

Huoluo Castle



NOTICE OF ASSEMBLE

Tips for Assembling Wood



Find the corresponding block number, use a knife in the connection point gently press, you can take out the wood.

Use a knife to smooth out the burr.

Or use sandpaper to smooth out the burr

Testing on LED function

Be sure to test the LED lights before making the lighting, note that the LED white wire to the negative, gray wire to the positive reference to the following figure operation test.

1



DO NOT contact the LED wire end direct to the battery cell.

2

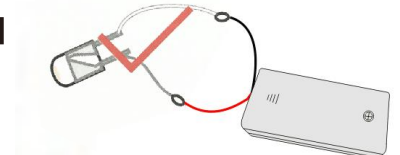

Use the provide battery holder. Make sue the correct polarity.

How to assemble the battery holder

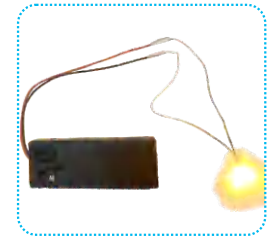
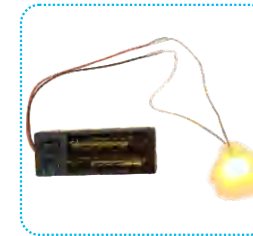
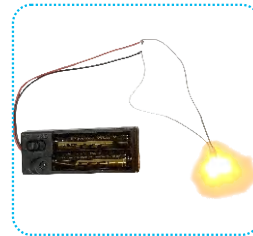
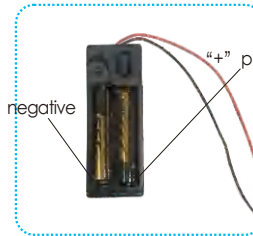

1. Material and tools needed:
- Battery holder, LED bulb,
tape, screw driver and 2 pieces
AAA size battery(not provided)

2. Use screw driver and
take the lid off from the
battery holder.

3. Insert the battery take
notes on the polarity.

4. Connect the red wire
to grey wire. Connect
the black wire to white
wire.

5. Wrap the exposed wire
with the tapes.

6. Place the box lid and
fastness with screw driver.

Symbol description used



Install parts
in the opposite
direction



Install the same
parts on both
sides



Pay attention to the direction of installation material B stick to material A



Pay attention to the direction of installation material A stick to material B



Pay attention to the direction of installation material B stick to material A



Pay attention to the direction of installation material A stick to material B



Fold in half
according to
dotted line



fold double
edge to center
dotted line



Fold four sides
to the middle



Pay attention to the direction of installation material A stick to material B



Pay attention to the direction of installation material B stick to material A



Pay attention to the direction of installation material A stick to material B



Pay attention to the direction of installation material B stick to material A



combination part
according to 1 2 3 so on.

About the use of glue

Method for using glue:

1. After applying the glue, let it dry for a few seconds before pasting.
2. Fix it slightly with your hands, and finally put it aside to dry;

Tips:

When pasting the plane printing paper, a piece of waste bank card or telephone card can be used to wipe evenly after the glue is smeared on the wood board, and then the printing paper is pasted to squeeze out the air inside.

Types of glue:

White latex: Used for adhering soft materials, such as wood and paper.
Alcoholic Glue: Used for adhering hard materials such as cloth, plastic, beads, wire, dust cover, etc.

◀ You can tear it down along this line for easy use

L2401 Materials List

unit:cm

(1/4)

Bag A

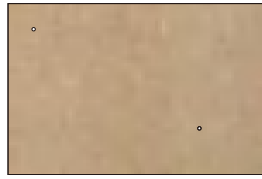

A01 MDF (Wood color)
30*20*0.5cm
(1 piece)

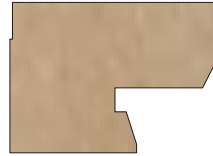

A02 MDF (Dark gray edge)
24*17.6*0.5cm
(1 piece)



A03 MDF (Wood color)
15*7.3*0.5cm (1 piece)



A04 Plywood
(Dark gray edge)
26.2*15*0.5cm
(1 piece)

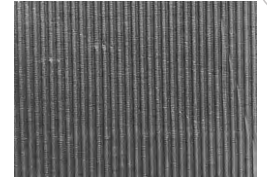

A05 Corrugated paper
(Gray) 17*17*cm
(1 piece)

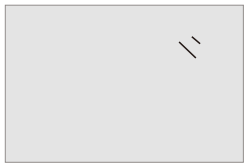

A06 PVC (Transparent)
9*6*cm (1 piece)

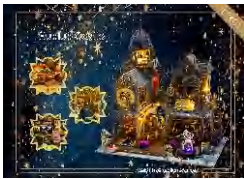
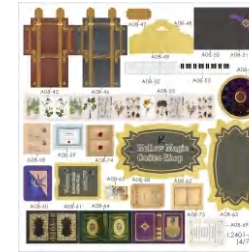
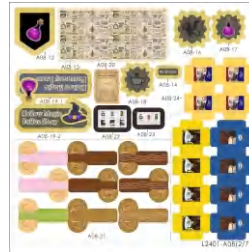

A07 Instruction Manual

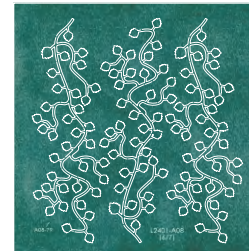
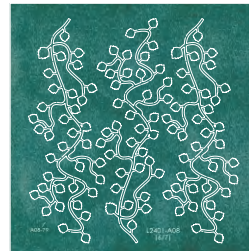

A08 Printing paper (7 sheets)

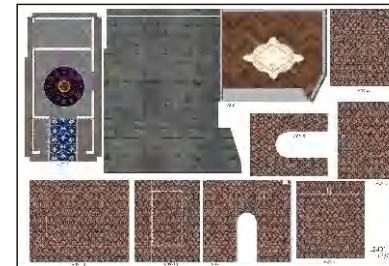
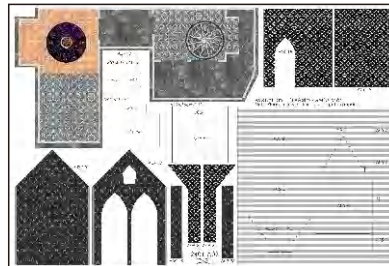
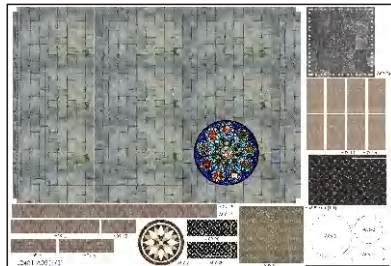

A09 Printing paper (3 sheets)

◀ You can tear it down along this line for easy use

Bag B

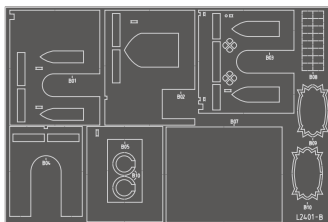

Board B
Plywood(Dark gray)
30*20*0.3cm(1 piece)

Bag C

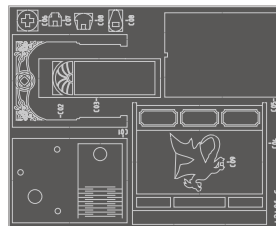

Board C
Plywood(Dark gray)
20*16*0.3cm(1 piece)

Bag D

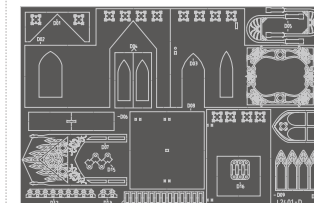

Board D
Plywood(Dark gray)
30*20*0.2cm(1 piece)

Bag E

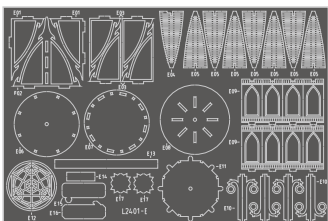

Board E
Plywood(Dark gray)
30*20*0.2cm(1 piece)

Bag F

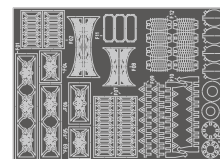

Board F
Plywood(Dark gray)
20*14*0.2cm(1 piece)

Bag G

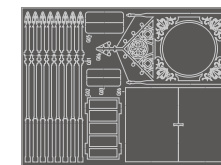

Board G
Plywood(Dark gray)
20*15*0.2cm(1 piece)

Bag H

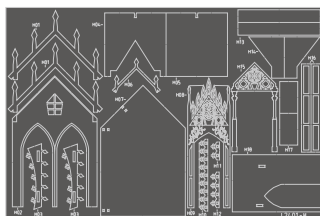

Board H
Plywood(Dark gray)
30*20*0.2cm(1 piece)

Bag J

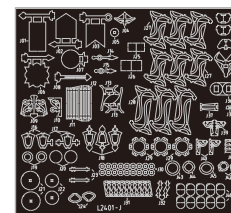

Board J
Plywood(Black)
22*20*0.2cm(1 piece)

Bag K

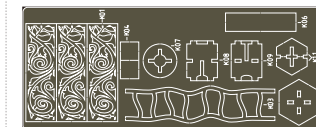

Board K
Plywood(Brown)
20*8*0.2cm(1 piece)

Bag L

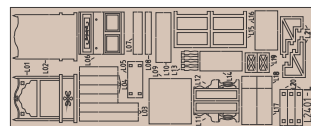

Board L
Plywood(Flesh color)
20*8*0.2cm(1 piece)

Bag M

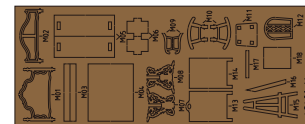

Board M
Plywood(Orange red)
20*8*0.2cm(1 piece)

Bag N

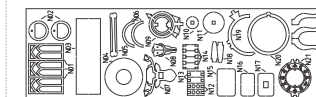

Board N
Plywood(White)
20*6*0.2cm(1 piece)

Bag P

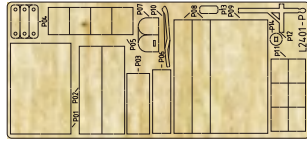

Board P
Plywood(Wood color)
20*9*0.2cm(1 piece)

Bag Q

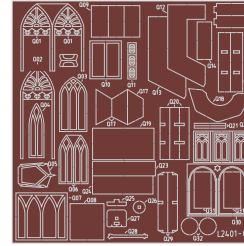

Board Q
Plywood(Coffee color)
20*20*0.2cm(1 piece)

Bag R

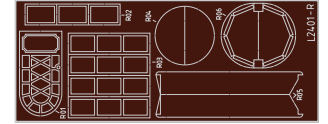

Board R
Plywood(Wine red)
20*8*0.2cm(1 piece)

Bag S

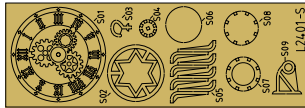

Board S
Plywood(Earthy yellow)
16*5.5*0.15cm(1 piece)

Bag T



Board T
Plywood(Colorful)
17*8*0.2cm(1 piece)

Bag U

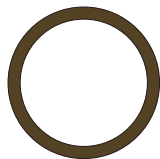

U01
Plywood
(Coffee color)
5*5*0.5cm(2 pieces)



U02
Small round
rubber beads
(White)
(4 pieces)



U03
Small round
rubber beads
(Red)(6 pieces)



U04 Small round
rubber beads
(Transparent)
(6 pieces)



U05
Small round
rubber beads
(Green)(1 piece)



U06
Medium round
rubber beads(Purple)
(8 pieces)



U07 Round rubber
beads
(Sky blue)
(2 pieces)



U08
Round rubber
beads
(Purple)
(3 pieces)



U09
Water droplet
adhesive beads
(Green)(1 piece)



U10
Square shaped
bead
(Pink)(3 pieces)



U11
Circular bead
(Transparent)
(1 piece)



U12
Beads(gold)
(30 pieces)



U13
Iron Beads
(gold)(8 pieces)

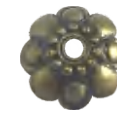

U14
Iron Beads
(Bronze color)
(1 pieces)



U15
Small iron Beads
(gold)
(7 pieces)

<p>U16 Round beads (gold)(1 piece)</p>	<p>U17 Chain bead (gold) 15cm(1 strip)</p>	<p>U18 Glue flower tray (Transparent) (2 pieces)</p>	<p>U19 Large iron Beads (Bronze color) (2 pieces)</p>	<p>U20 Iron Beads (Bronze color) (4 pieces)</p>	<p>U21 Iron Beads (Bronze color) (3 pieces)</p>	<p>U22 Fork(gold) (1 piece)</p>	<p>U23 Iron Beads (gold)(2 pieces)</p>
<p>U24 Small plastic tube (Transparent)5cm (1 piece)</p>	<p>U25 Iron Bell (Bronze color) 1.2*1.2*1cm(3 pieces)</p>	<p>U26 Iron faucet (silvery) 1.2*1.2*0.3cm(1 piece)</p>	<p>Bag V</p>		<p>V01 Cloth(Colorful) 6*5cm(1 piece)</p>	<p>V02 Non-woven fabric (White)6*6cm (1 piece)</p>	<p>V03 Mirror paper (Silvery) 4*3cm(1 piece)</p>
<p>V04 Thick iron wire (Red)4cm (1 strip)</p>	<p>V05 Thick iron wire (Yellow)6cm(1 strip)</p>	<p>V06 Iron wire(Black) 12cm(1 strip)</p>	<p>V07 Flower core (Purple) (10 pieces)</p>	<p>V08 Paper rope (Earthy yellow) 20cm(1 strip)</p>	<p>V09 Plastic tree (Dark purple) (1 tree)</p>	<p>V10 Plastic leaves (Green)(3 trees)</p>	<p>V11 Plastic flowers (Purple) (2 trees)</p>
<p>V12 Resin bathtub (White) (1 piece)</p>	<p>V13 Resin cup (Green) (2 pieces)</p>	<p>V13 Wooden bead (Wood color) (10 pieces)</p>	<p>V14 Thin iron wire (Yellow)15cm (1 strip)</p>				
<p>Bag W</p>	<p>W01 LED lamp (warm white) (13 pieces)</p>	<p>W02 LED lamp (Blue light) (1 piece)</p>	<p>W03 AAA battery box (black) (1 piece)</p>	<p>W04 Tape (White) (4 sheets)</p>	<p>W05 Matte (Black) (1 piece)</p>		

Bookcase

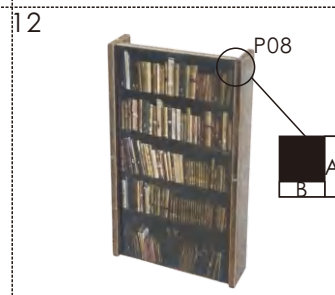
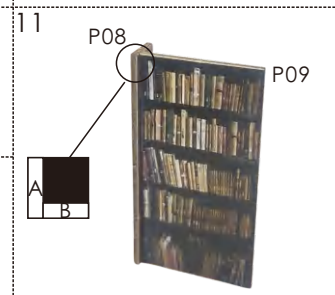
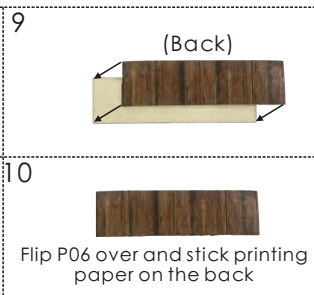
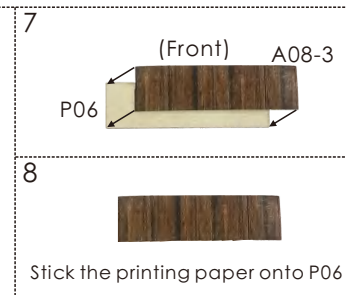
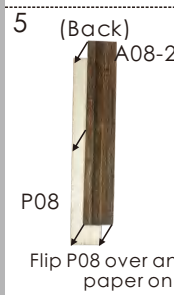
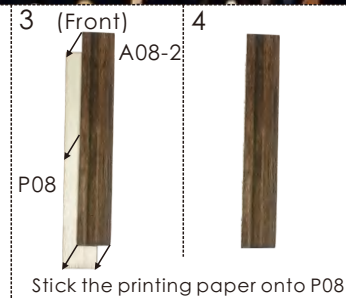
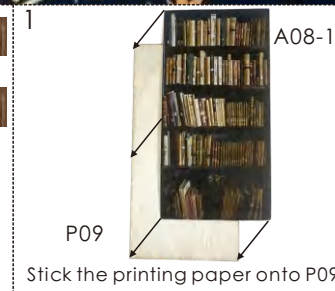
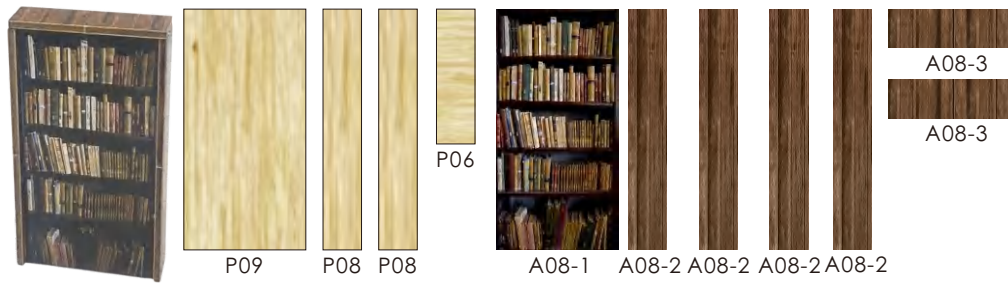

Medicine jar

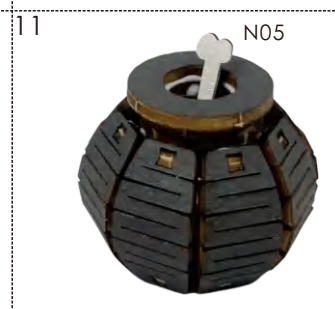
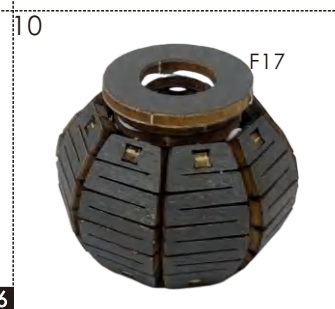
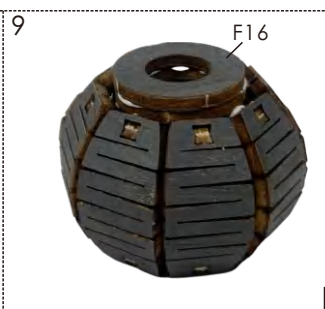
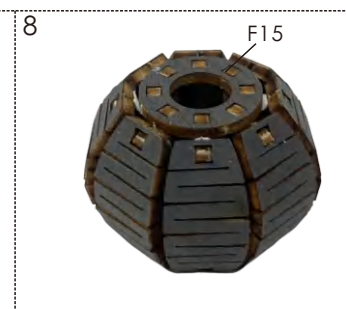
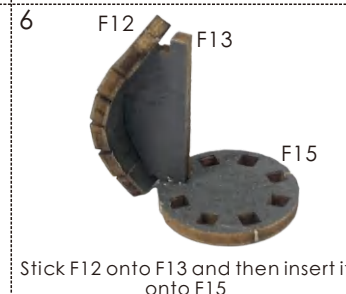
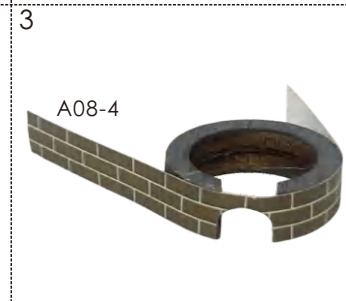
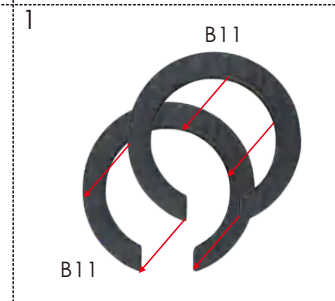
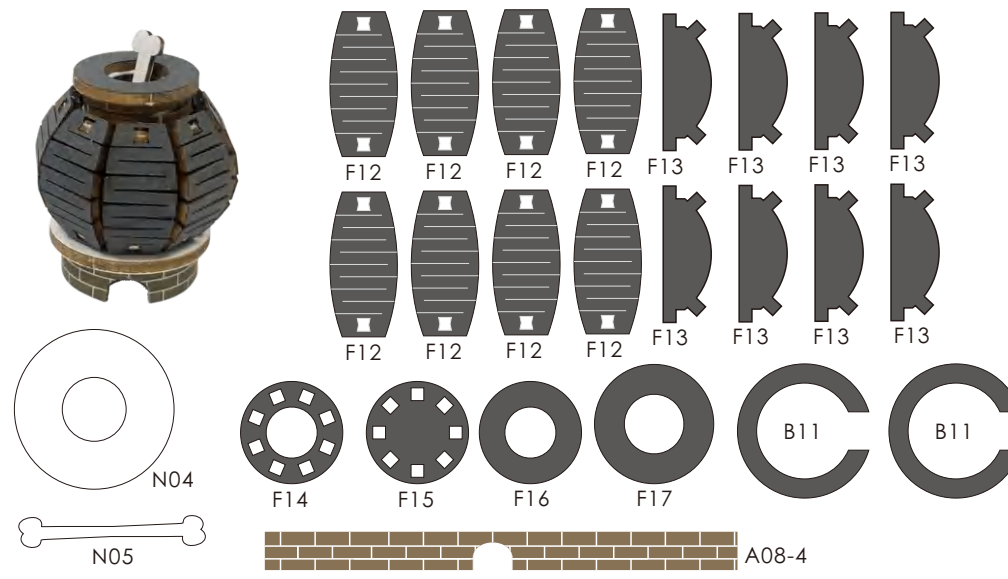

Test tube rack

N12 N12 N13 N13 N14 N14 N14 N14

U24:1cm A08-5

1

N14 N14 N13

2

N12

3

U24:1cm A08-5

Roll up A08-5 and stuff it into U24

4

Book

B08 A08-6

1

A08-6 B08

As shown, stick A08-6 onto B08

2

B08

3

Stick other books together using the same method

Magic ball

J42 J42 J41 J41 J41 J41 J41 J41

U06 U06

1

J41 J42

2

J41 J41 J42

Stick J41 onto J42

3

U06

(Need 2 pieces)

Side table 1

N03 K04 K04 K06 A08-7

1

K04 K06

2

K06 K04

3

N03

4

A08-7

5

6

Test tube rack Book Magic ball

Small bell

J09 J09 J10 U25 U25 U25 V06:1cm

1

J10 V06:1cm U25 V06:1cm J09 J09 U25 V06:1cm

Tie U25 to J09 and J10 with wire

Sign

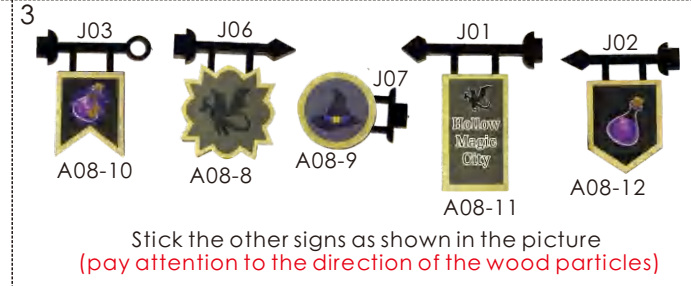
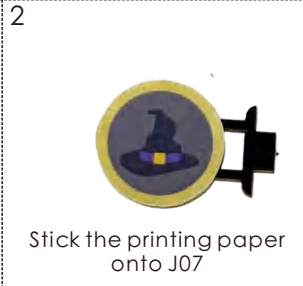

Outer frame

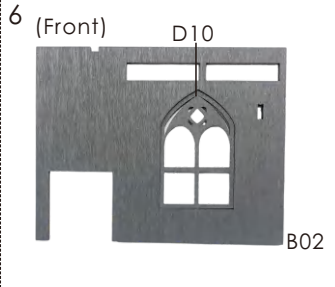
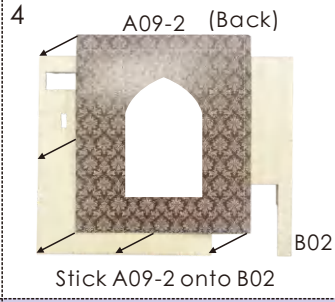
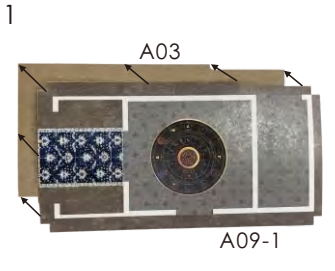

Movement installation

Upgraded version (accessories need to be purchased separately)

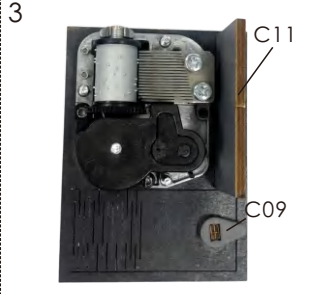
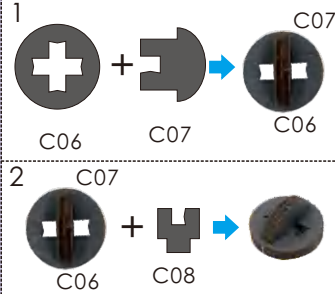
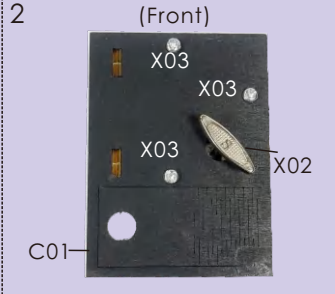
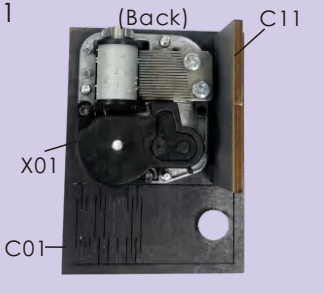
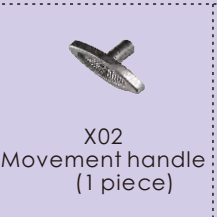

Outer frame assembly

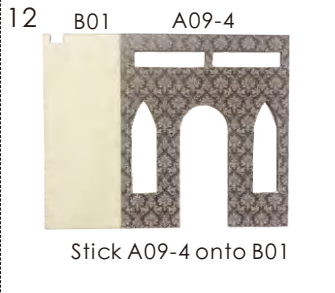
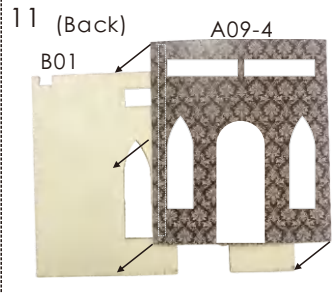
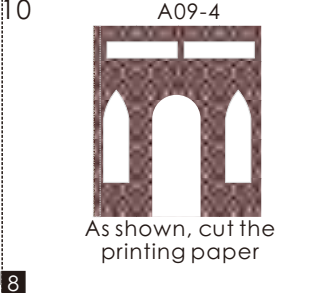
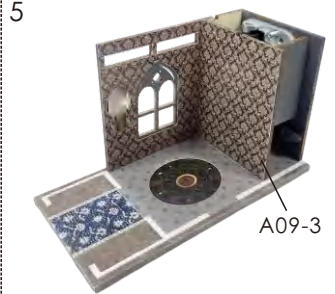
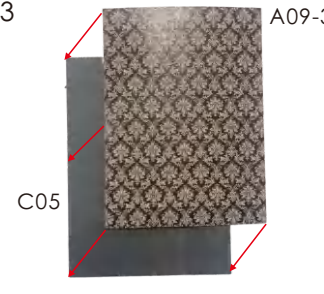
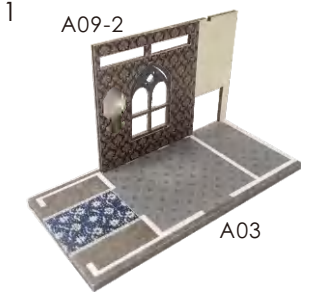

Plants refer to the following method 8

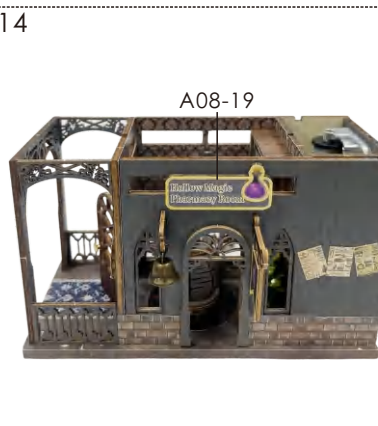
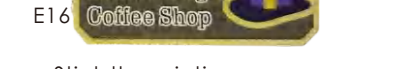
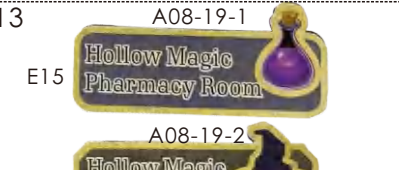
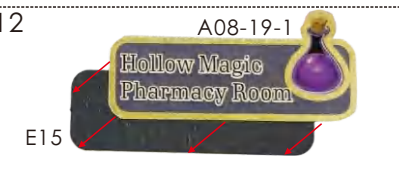
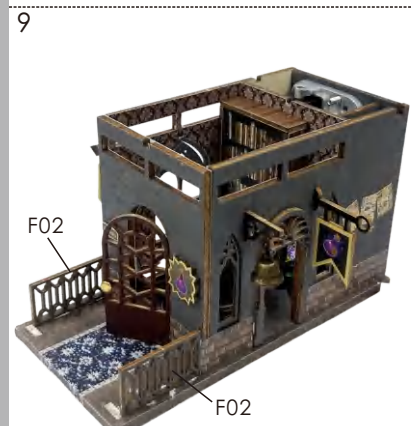
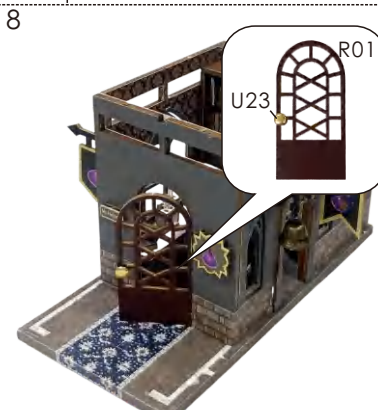
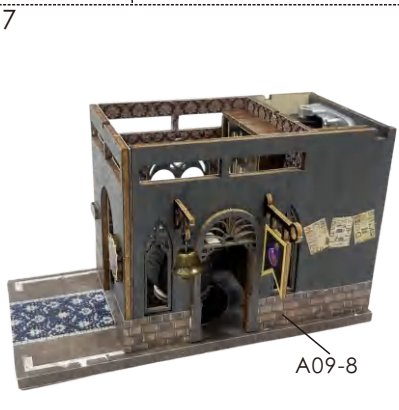
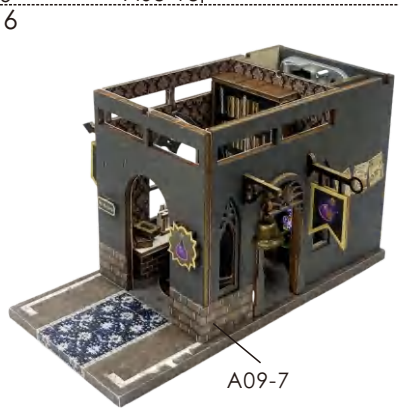
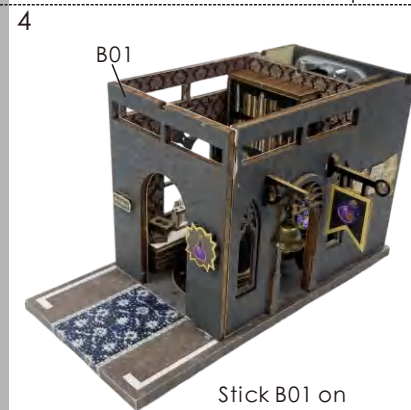
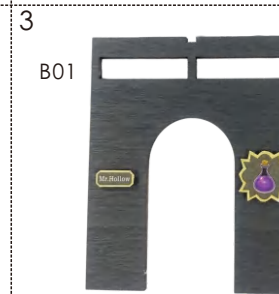
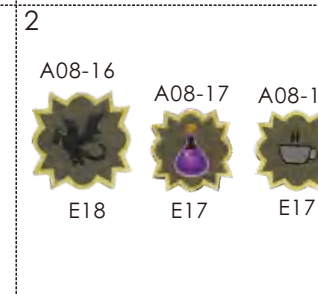
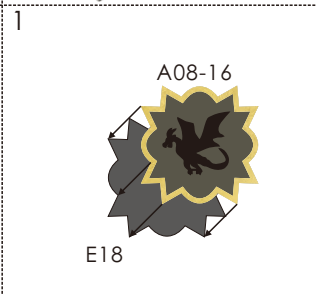
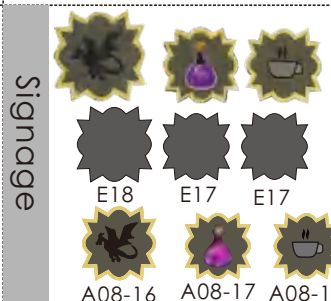
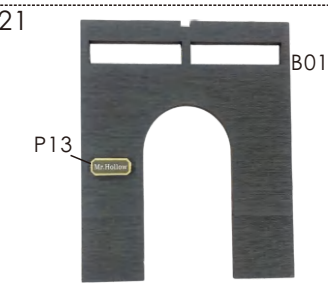
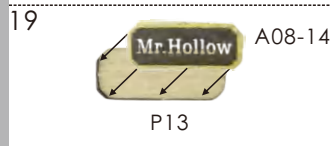
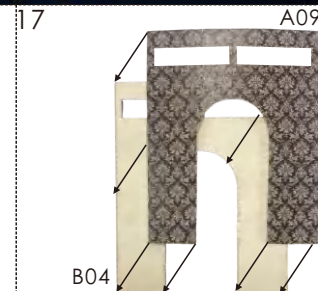
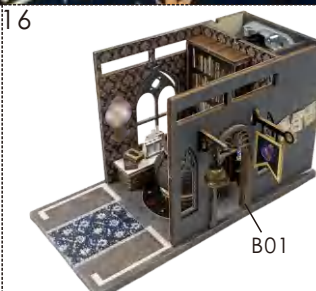
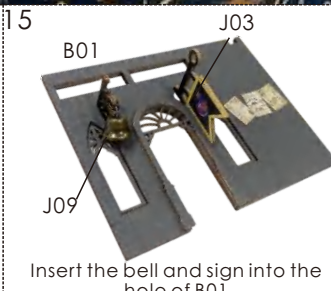
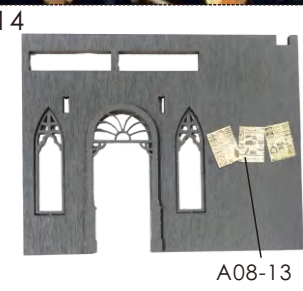
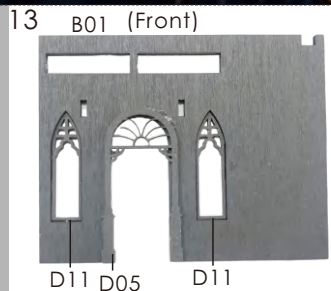

Ornament

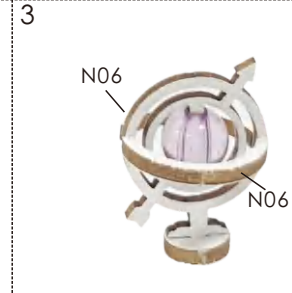
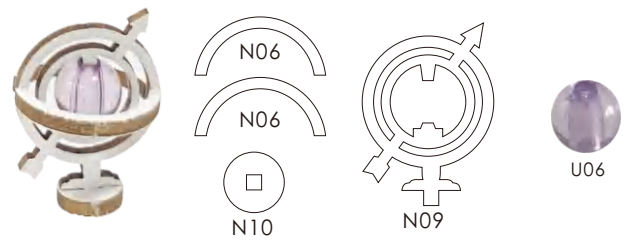

Balance scale

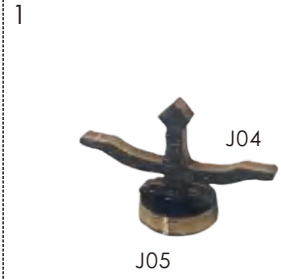
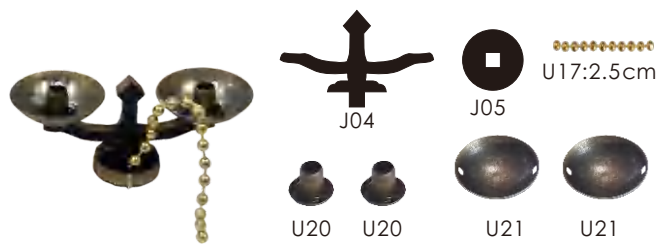

Side table 2

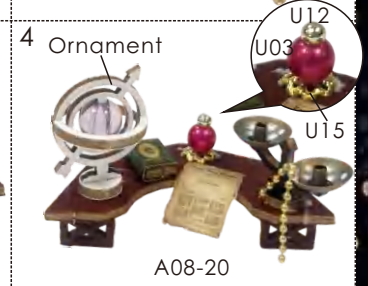
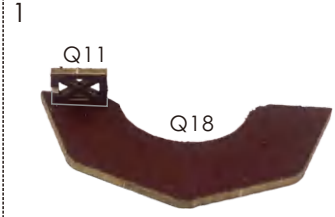

Magic wand

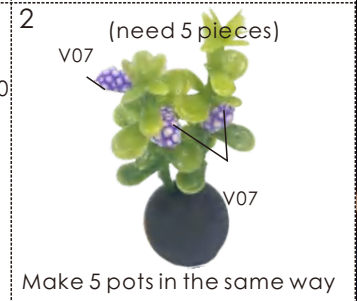
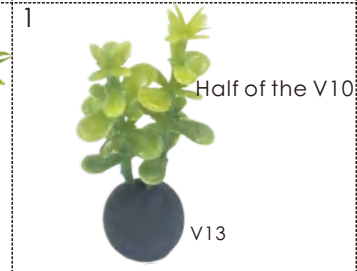
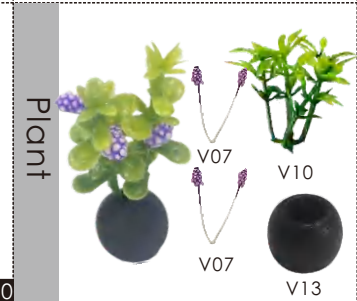
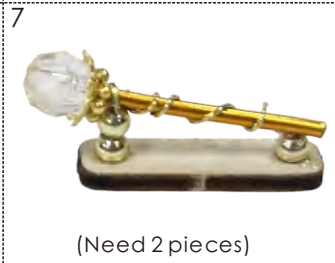
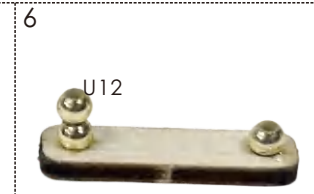
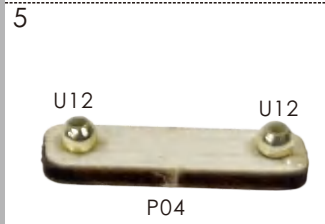
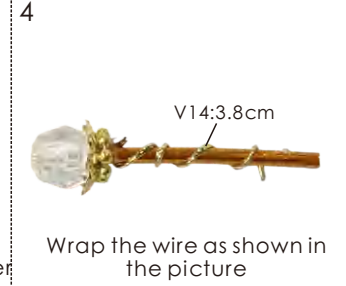
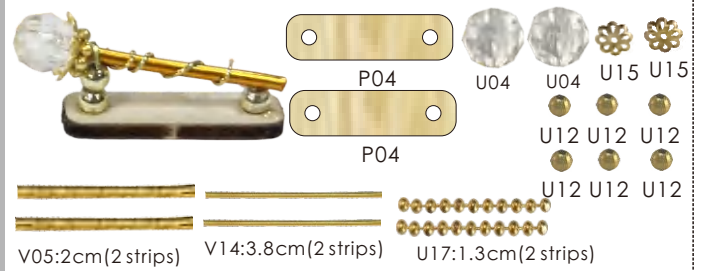

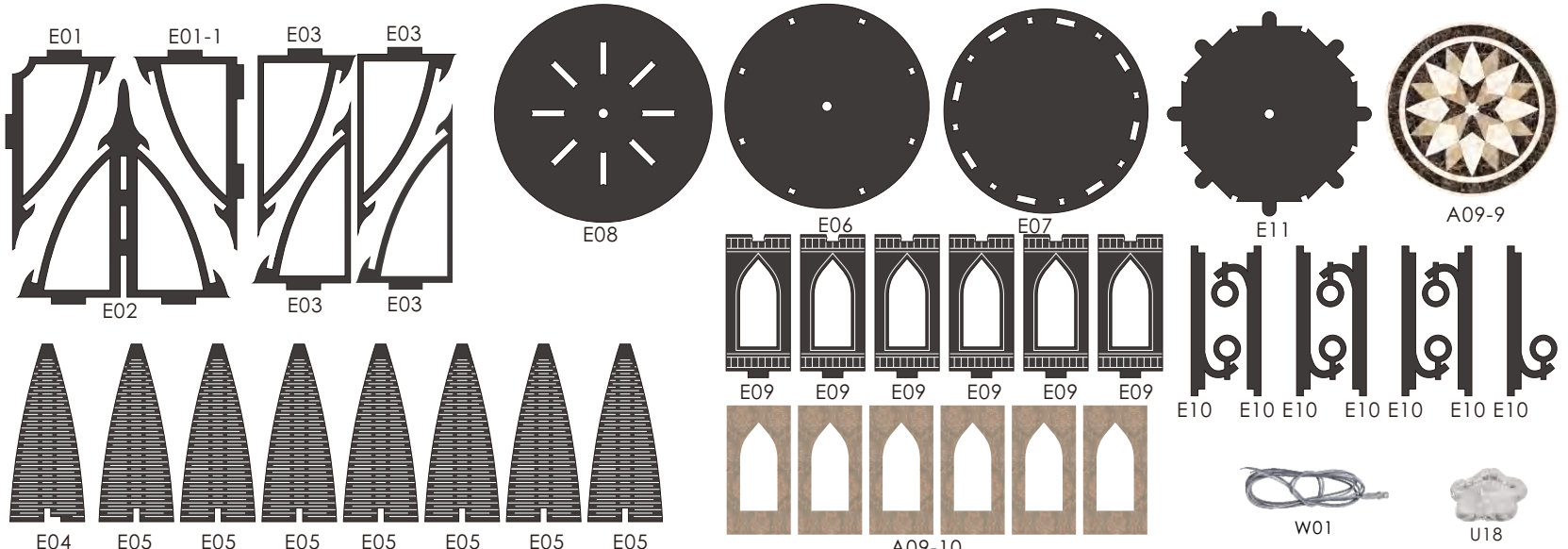

<p>1</p> <p>A09-9</p> <p>E07</p>	<p>2</p> <p>A09-9</p>	<p>3</p> <p>E09</p> <p>A09-10</p>	<p>4</p> <p>E09</p>	<p>5</p> <p>(need 6 pieces)</p> <p>E09</p> <p>As shown, glue the printing paper</p>	<p>6</p> <p>E09</p> <p>E07</p>
<p>7</p> <p>E10</p>	<p>8</p> <p>E09</p>	<p>9</p> <p>E10</p>	<p>10</p> <p>E10</p> <p>E10</p>	<p>11</p>	<p>12</p> <p>Side table 2</p>
<p>13</p> <p>E11</p>	<p>14</p> <p>E08</p> <p>E06</p>	<p>15</p> <p>E08</p>	<p>16</p> <p>E08</p>	<p>17</p> <p>U18</p> <p>W01</p> <p>Wear W01 on U18</p>	<p>18</p> <p>19</p>

20



21



22



23



24



25



26



27



28



29



30



31



Coffee machine

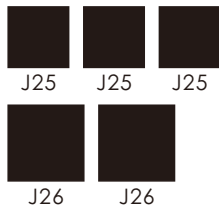

1



2



3

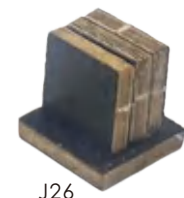

4



5



6



7



8



9



Cake

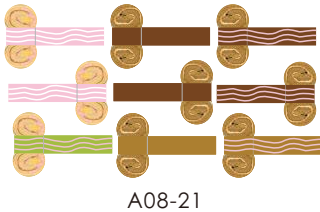

1



Stick 2 pieces of J46 together

2

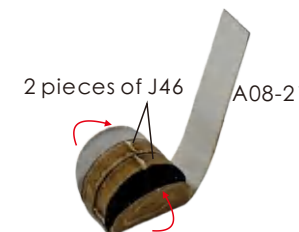

3



Package as shown in the picture

4



Sort all the cakes in the same way

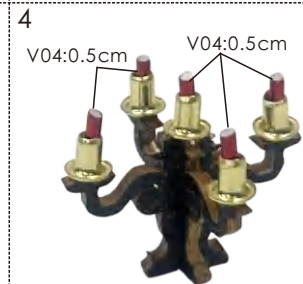
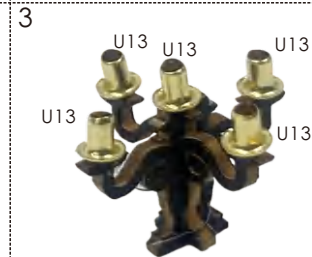
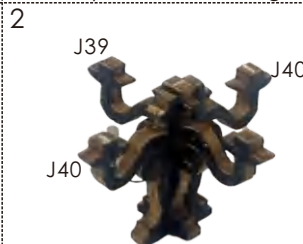
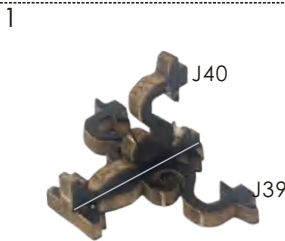
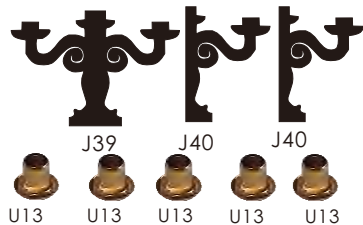
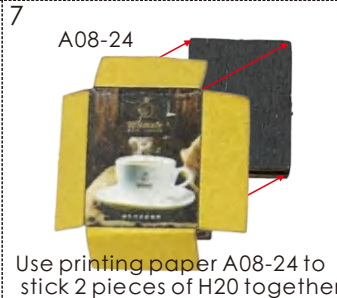
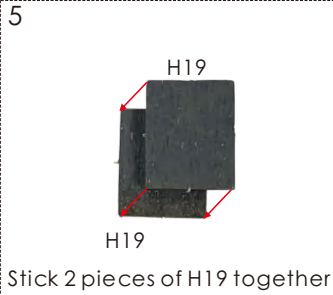
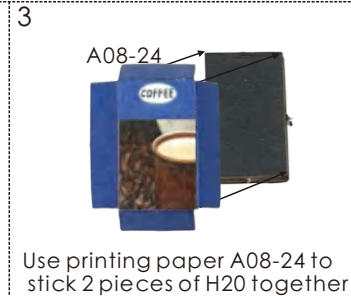
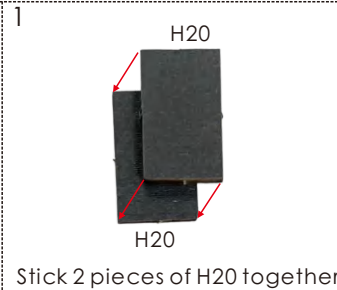
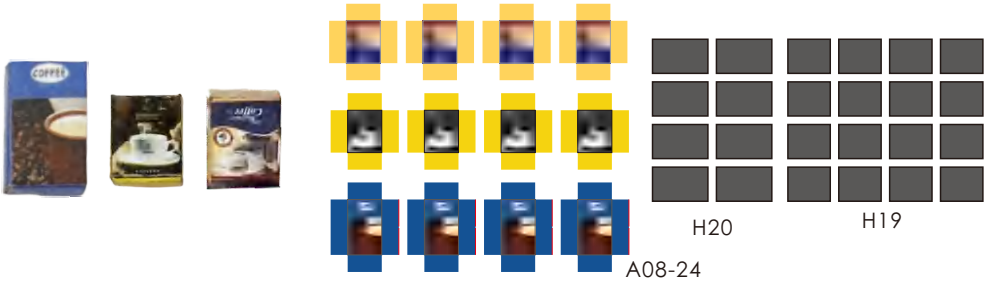
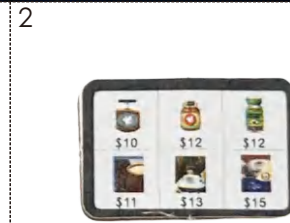
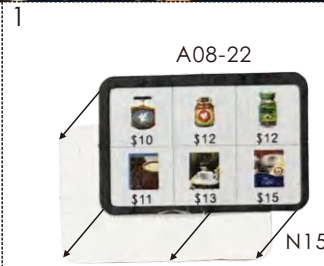
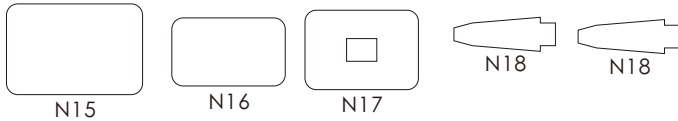

V04:0.5cm V04:0.5cm V04:0.5cm V04:0.5cm V04:0.5cm

Round cabinet

Parts list for Round cabinet:

- K07: Hexagonal base plate with a central cross-shaped hole.
- K08: L-shaped side panel with a notch.
- K09: L-shaped side panel with a notch.
- K10: Small square pieces.
- K11: L-shaped side panel with a notch.
- U03: Small red spherical ornament.
- U05: Small green spherical ornament.
- U10: Small pink square ornaments.
- U12: Small green spherical ornaments.
- U08: Large purple spherical ornament.

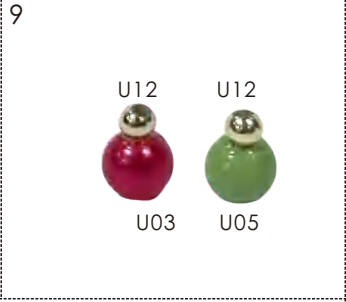

Cash register



Parts list for Cash register:

- Q09: Small square pieces.
- Q08: Small square pieces.
- Q13: L-shaped side panel.
- Q12: L-shaped side panel.
- Q14: Horizontal bar.
- Q15: Horizontal bar.
- Q16: Vertical bar.
- Q17: T-shaped pieces.
- Q19: Large rectangular base.
- Q10: Small rectangular frame.
- A08-25: Coin slot tray.
- A08-26: Coin slot tray.
- A08-27-1: Paper slot tray.
- A08-27-2: Paper slot tray.
- A08-28: Mario logo sticker.
- A08-29: "Hollow Mario Coffee Shop" sign.
- A08-30: Price tag stickers.
- U22: Small fork.

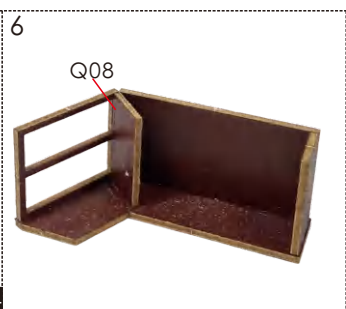

9

Q12

10

11

12

A08-28
A08-29
A08-27-2

13

Cake

14

A08-27-1

15

A08-25

Fold A08-25 as shown in the picture

16

17

Cake
U22

18

A08-25

19

Coffee Box
A08-30

20

Cash register

Coffee cabinet

Q20 Q20 Q20 Q30
Q21 Q21
Q22
Q23
Q24
Q29 Q29
Q31 Q31
N01 N01 N01
T17 T19
T18
A08-30

1

Q29 Q20

2

Q29 Q20
Q29

3

Q20 Q20

4

Q20 Q20
Q20

5

Q30

6

N01 N01 N01
Q22

7

Q31
Q24

Stick Q31 onto Q24 (pay attention to aligning the back)

8

Q21 Q22

9

Q32

10

Q31

15

Outer frame

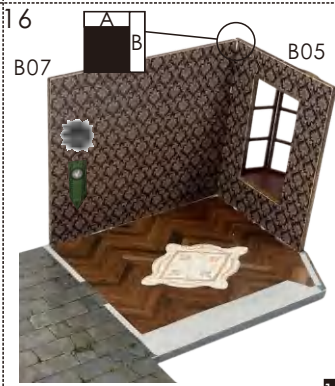
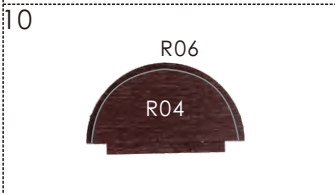
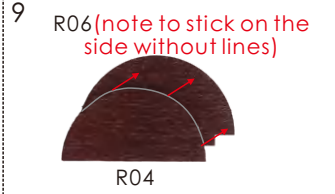
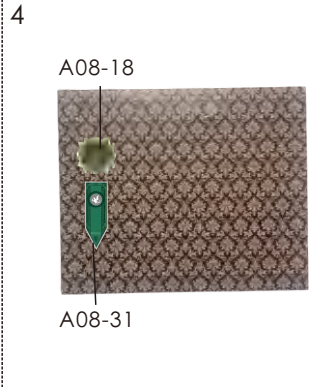
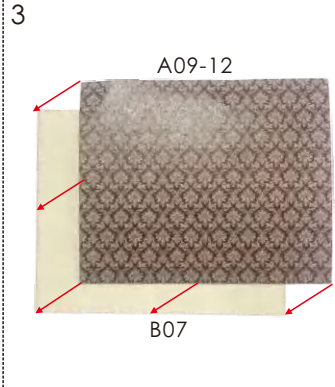
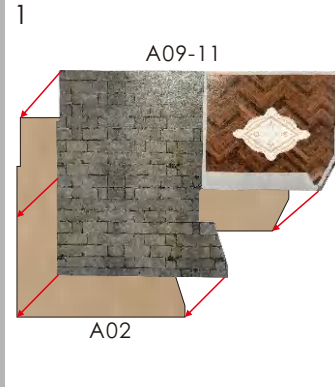

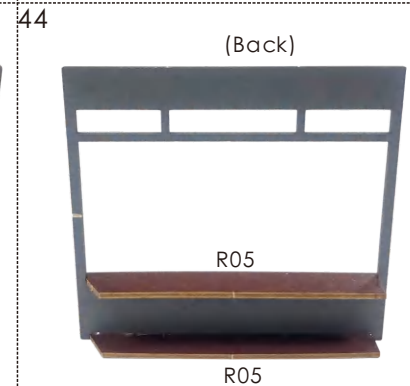
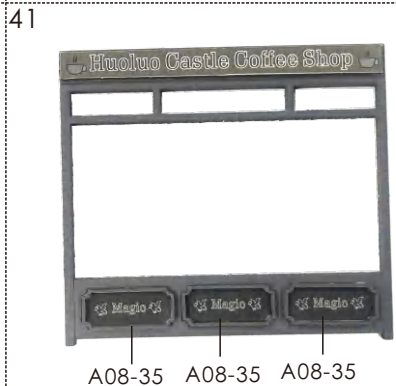
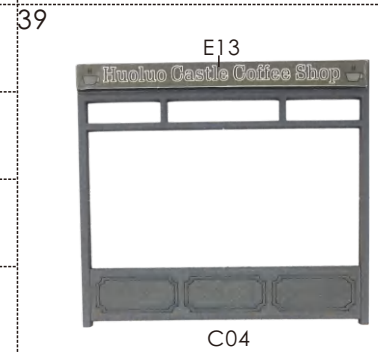
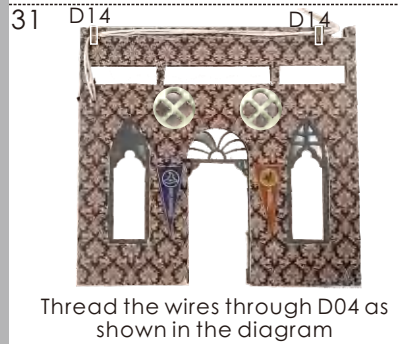
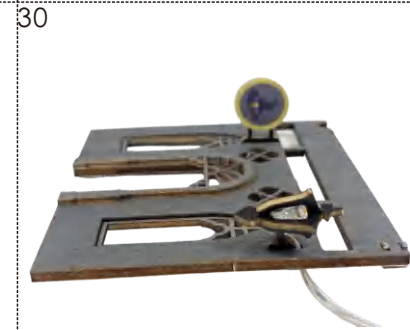
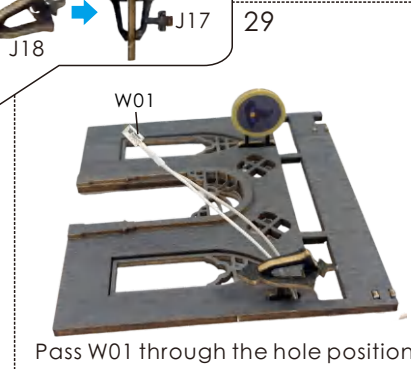
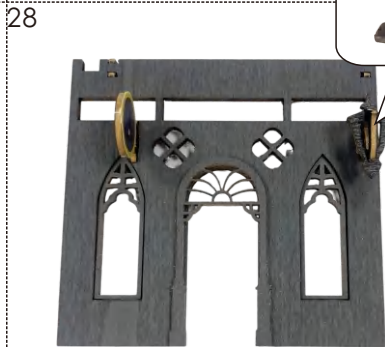
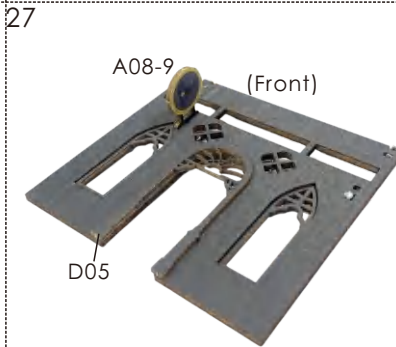
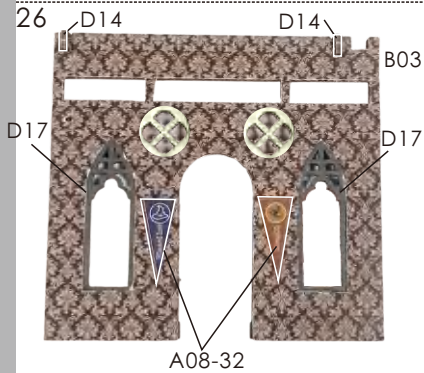
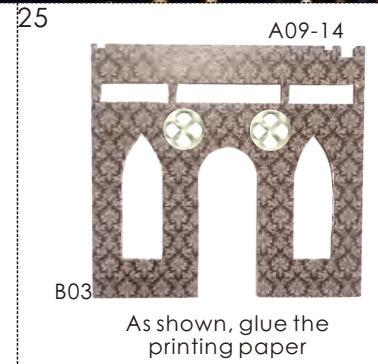
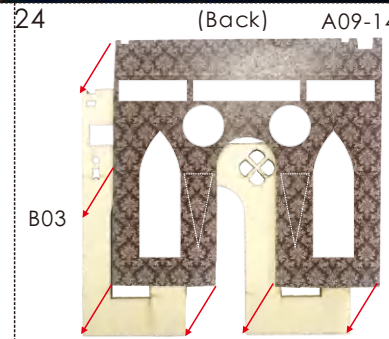
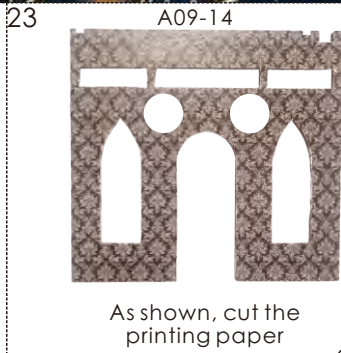
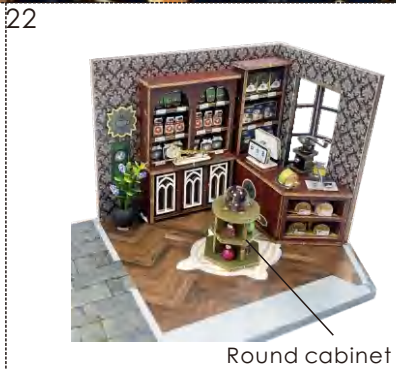

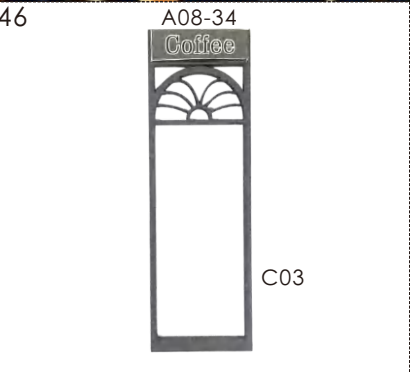

Bar stool

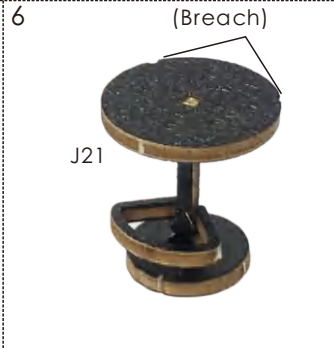
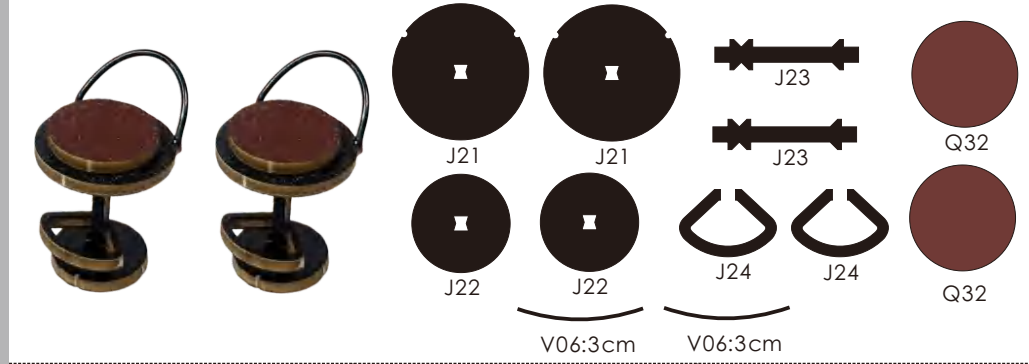

Outer frame

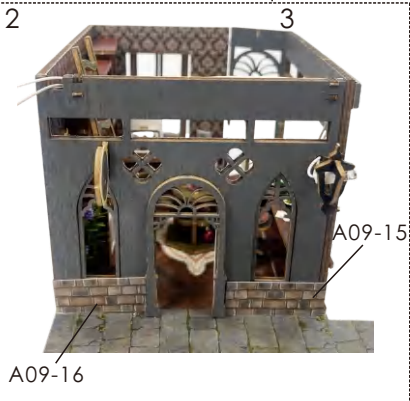

Display rack



Box

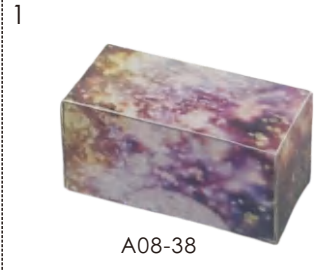
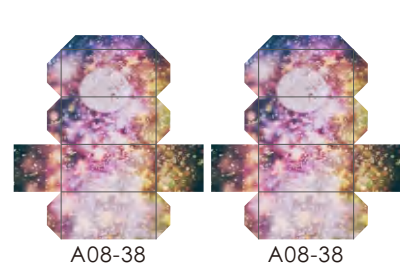

Outer frame

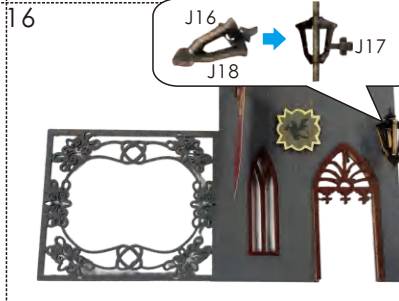
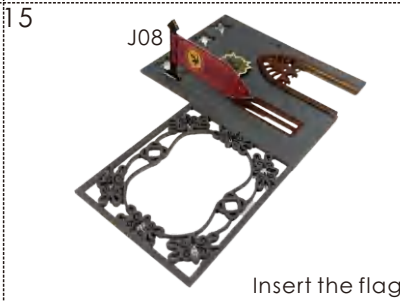
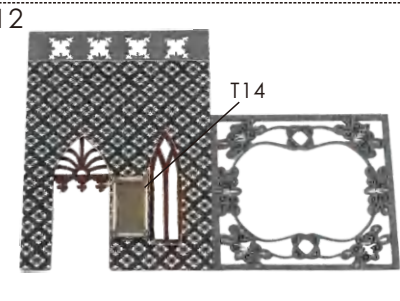
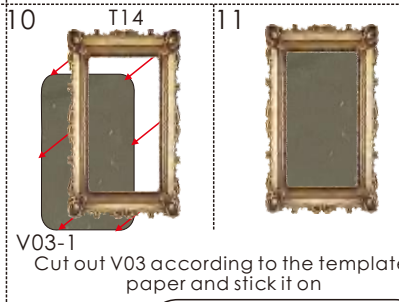
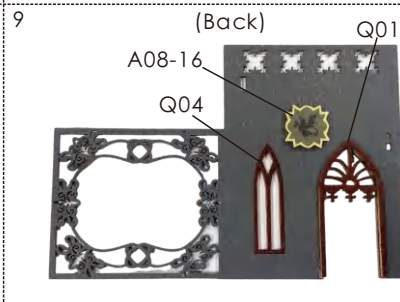
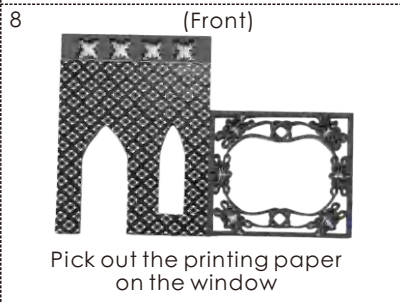
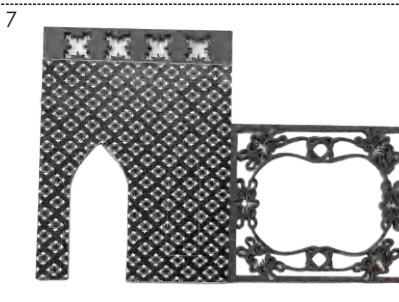
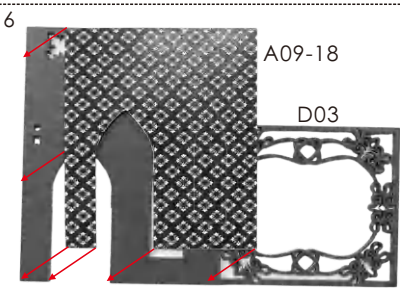
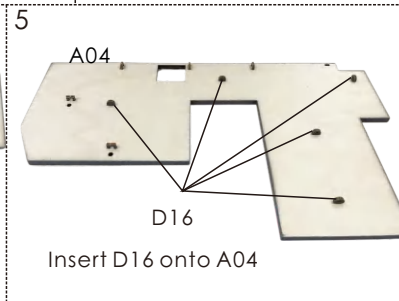
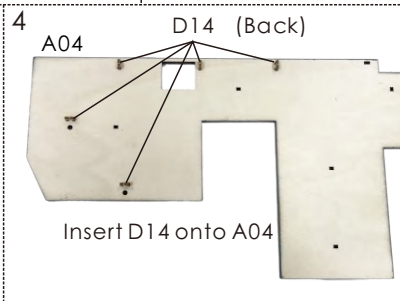
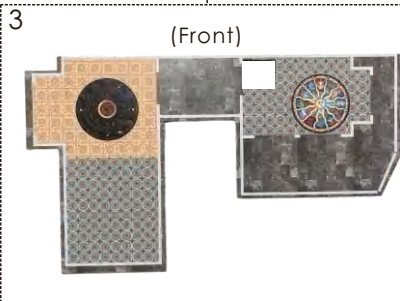
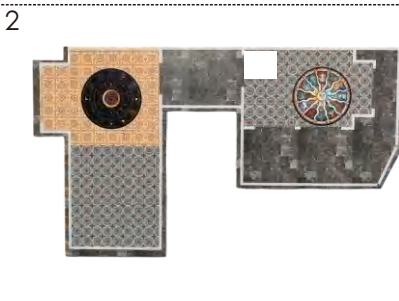
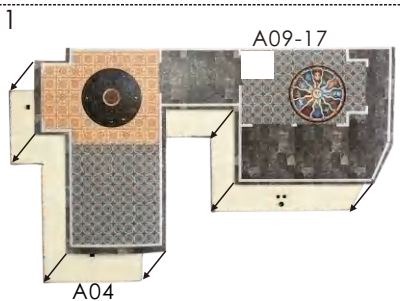

Thread A08-39 through J08 and fold it in half to stick it together

Insert the flag

Cut out V03 according to the template paper and stick it on

Outer frame

17

A09-19

Pick out the printing paper on the window

18

A09-19

D09

Placement of D09

19

As shown, glue the printing paper

20

D14

Q07

D14

21

A09-20

D04

22

As shown, glue the printing paper

23 (need 2 pieces)

Q06

24

D07

Q06

25

Q06

26

(Note the direction of the corrugated paper)

D06

A05-1

Cut A05 according to A05-1 and stick it together

27 (need 2 pieces)

D06

28

D06

D15

D06

Insert D15 into D06

29

W01

30

31

D13

D06

Q06

32

A09-21

Pick out the printing paper on the window

33

A09-21

D02

34

As shown, glue the printing paper

35

A09-22

A09-23

36

Q03

37

A04

38

D02

39

D09

40

D14

(Note :D09 do not stick, put the wire on first)

Wash basin



L15

L15

L17

L18

L17

L18

L16

V06:1cm

N02

N02

A08-40

A08-41

U04

U06

U12

U13

1

A08-41

L15

2

L15

3

L18

L18

L15

1cm

1cm

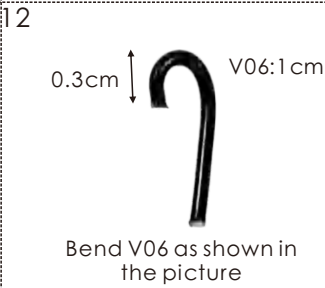
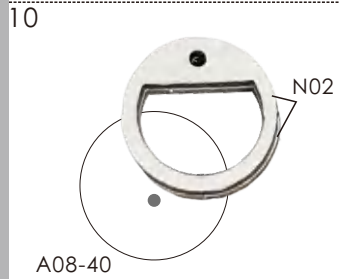
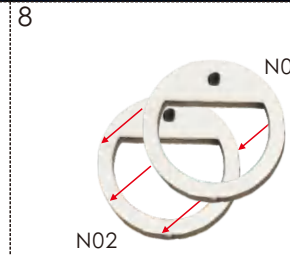
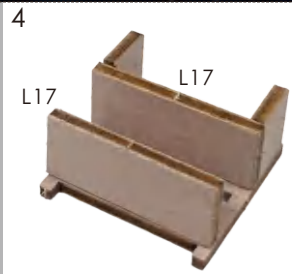

Before making, cut out A06, V01 and V02 according to the template

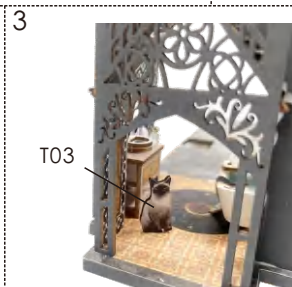
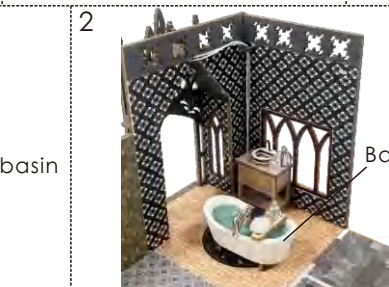
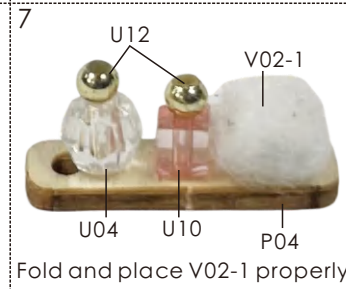
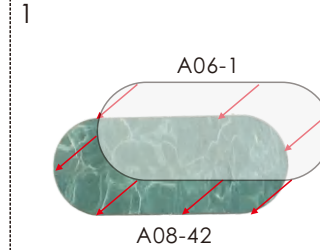
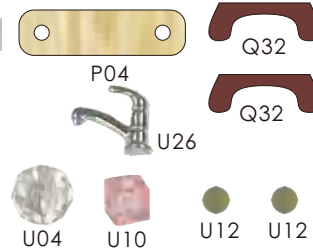
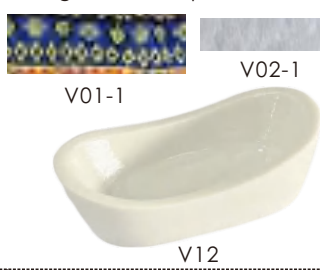

Bathtub

Outer frame

Wall decorations

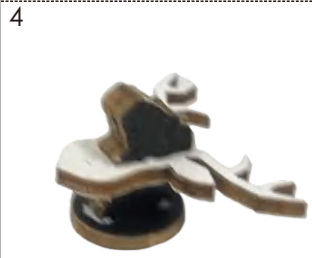
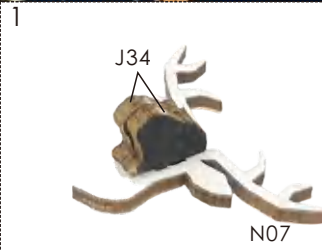

Bedside cabinet

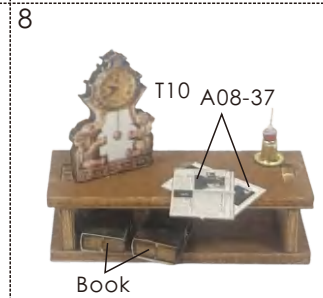
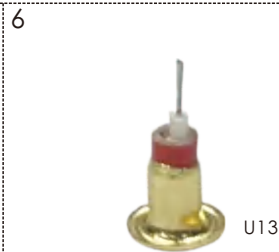
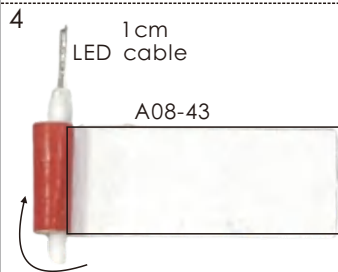
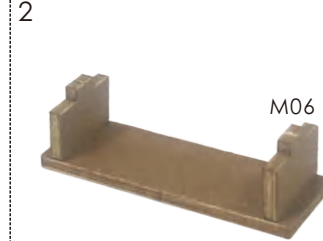
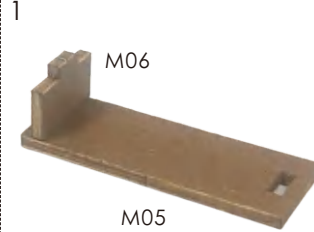
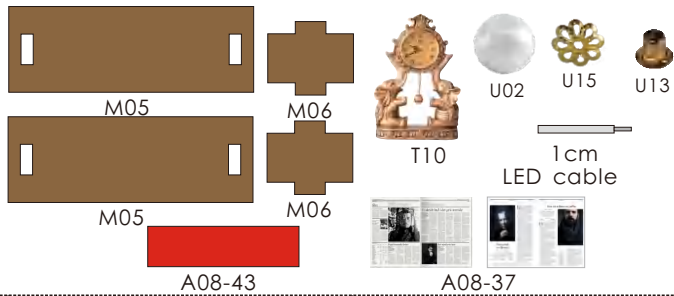

Trunk 1

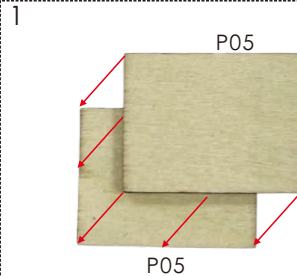
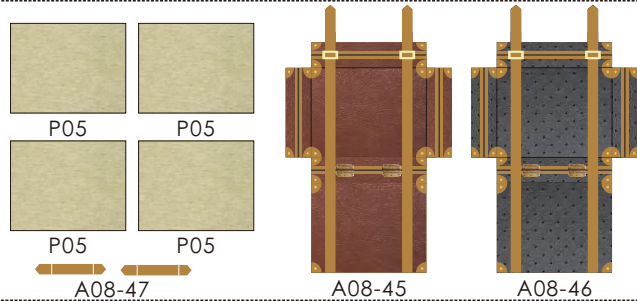

4

5

A08-46

6

7

A08-47

8

A08-45

Prepare another suitcase using the same method

9

Bed

Before making, cut out V01 and V02 according to the template

M01

M02

M03

M03

M04

M04

V01-2

A08-48

A08-49

V02-2

A08-50

A08-51

1

A08-48

M01

2

A08-49

M02

3

M03

M04

M03

4

M01

5

M02

6

V02-2

G07

Wrap G07 properly

7

8

9

V01-2

0.5cm

Fold V01-2 back 0.5cm

10

11

A08-51

Fold A08-51 as shown in the picture

12

A08-51

A08-50

13

Outer frame

G04

S01

J14

J15

U23

1

S01

J15

2

J14

3

U23

4

G04

23

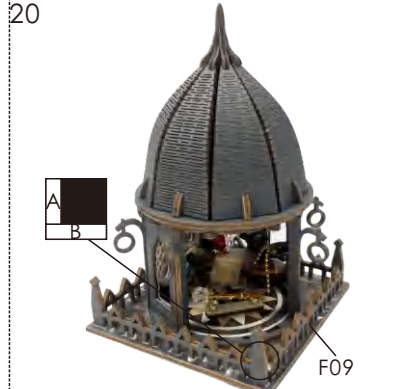
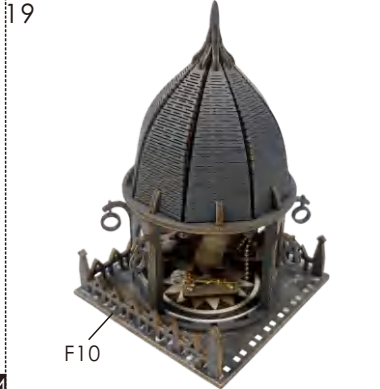
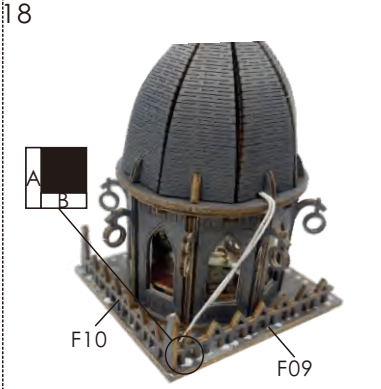
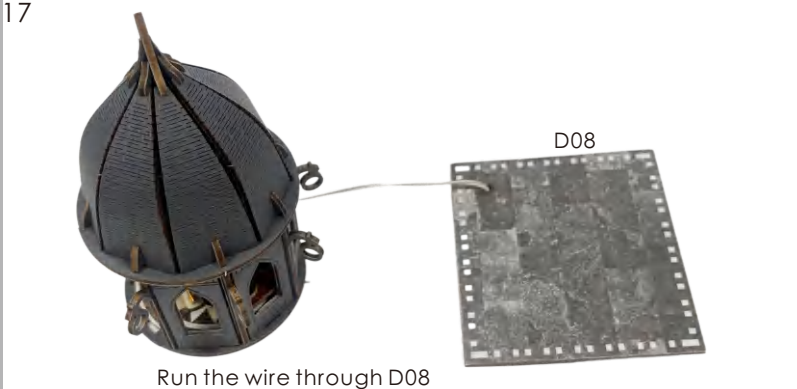
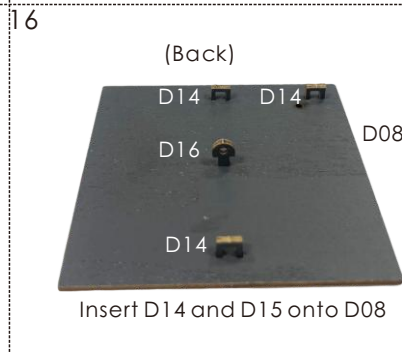
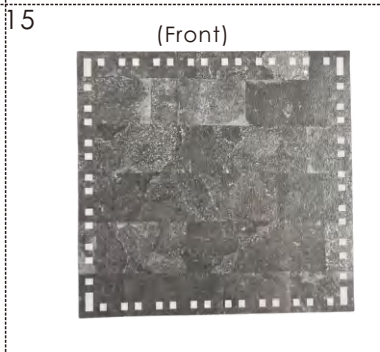
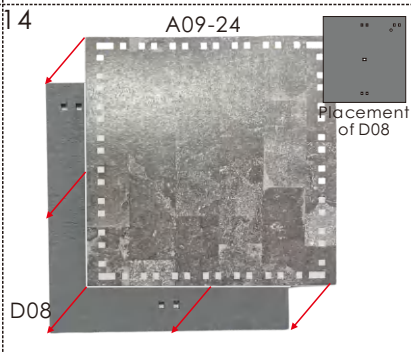
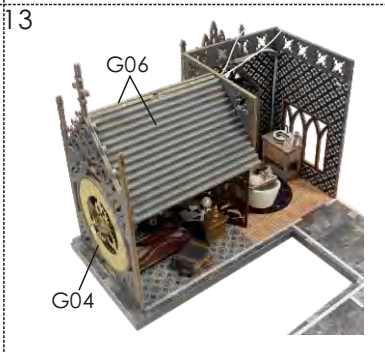
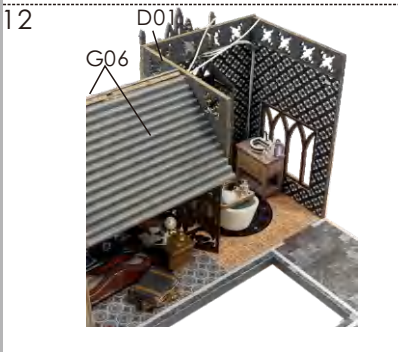
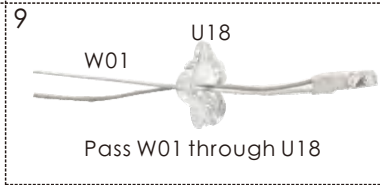
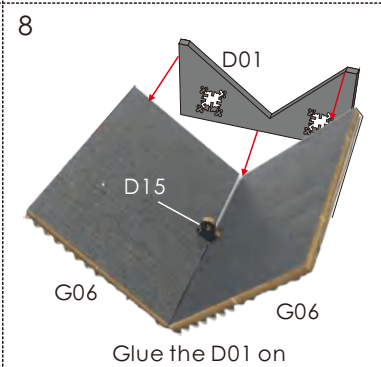
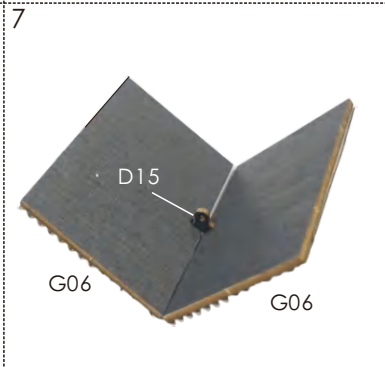
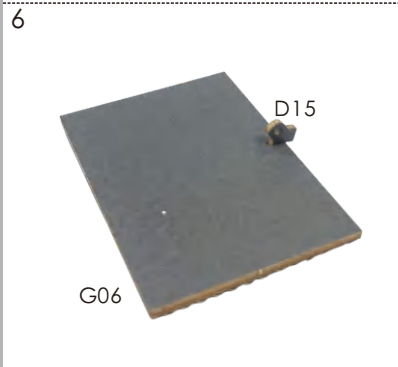
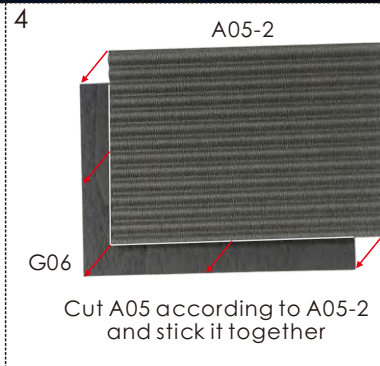

Chandelier 1

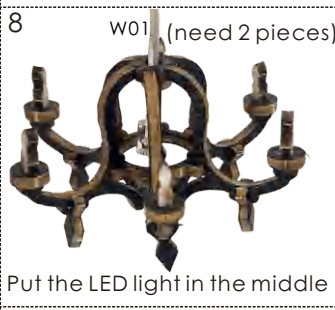
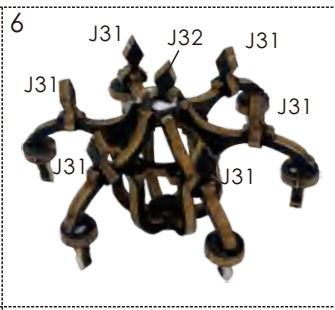
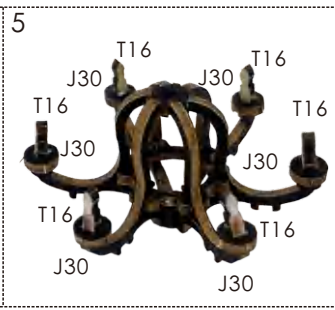
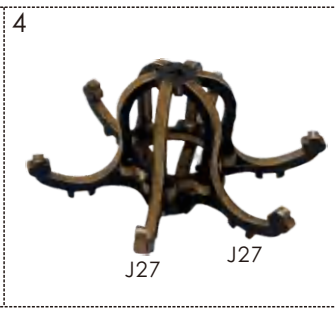
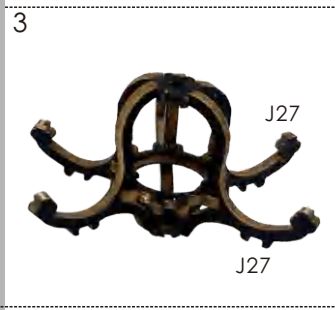
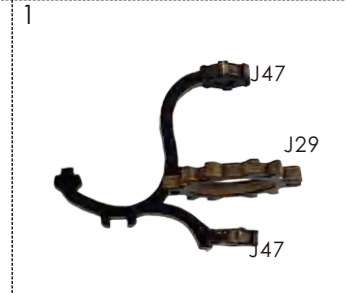
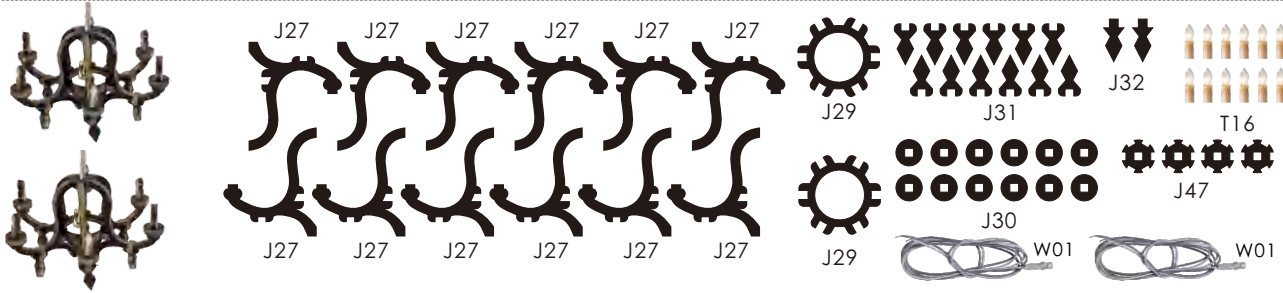

Chandelier 2

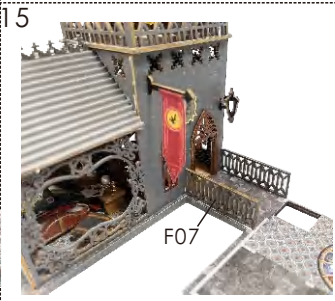
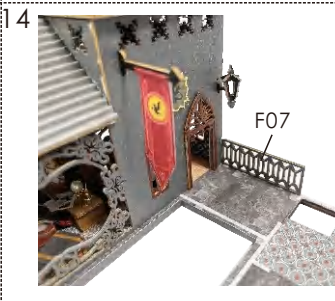
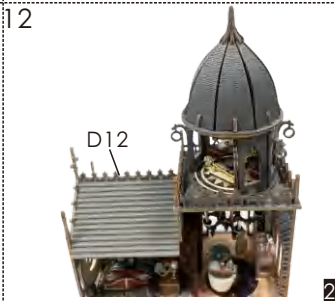
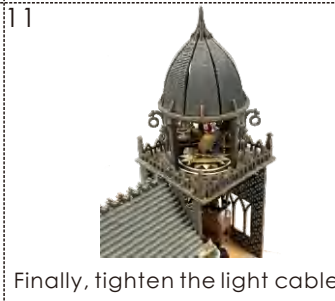
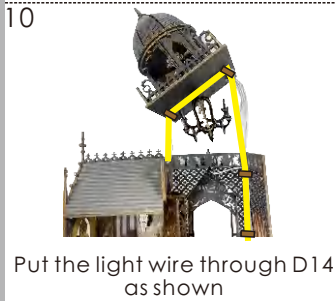
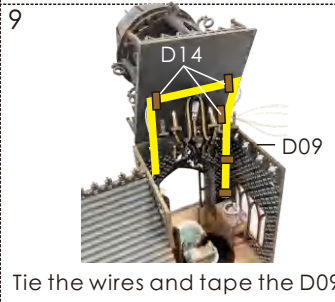
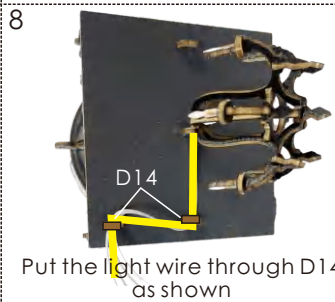
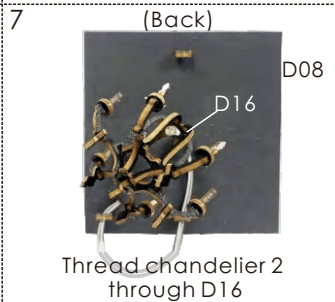
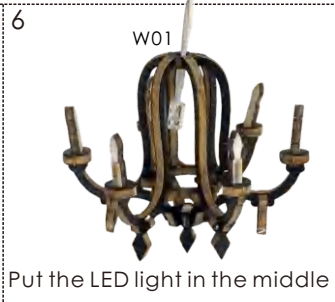
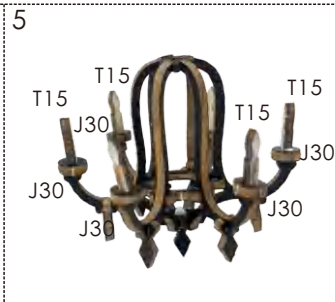
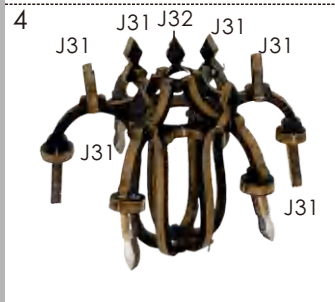
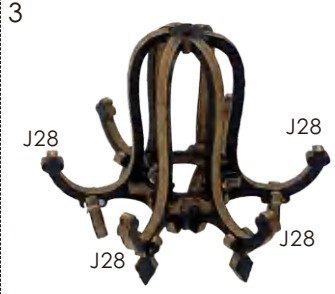
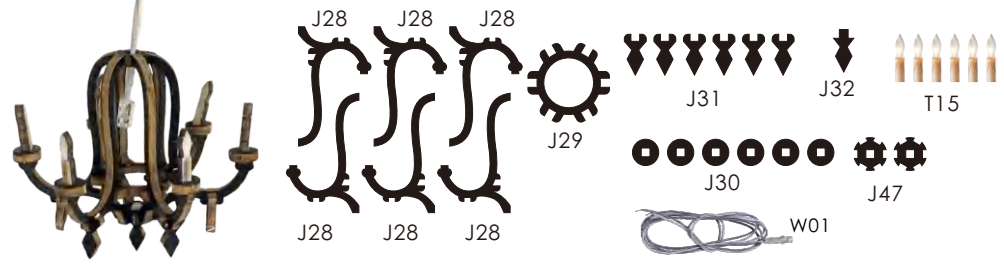

Outdoor Table

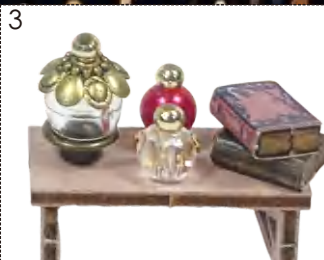

Outer frame

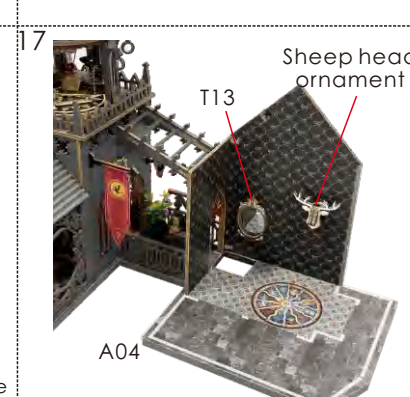
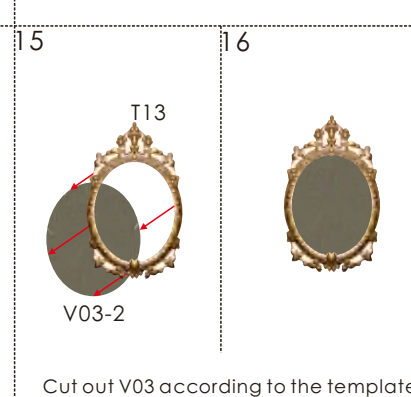
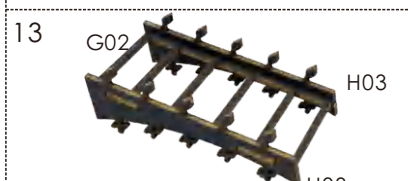
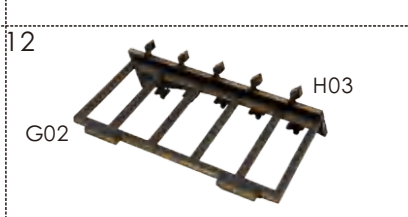
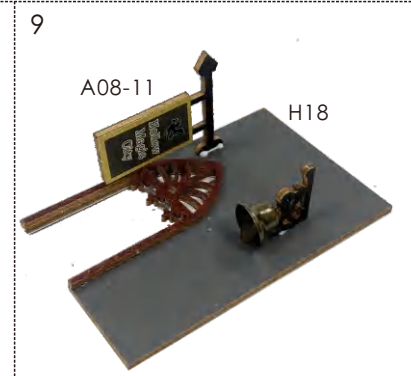
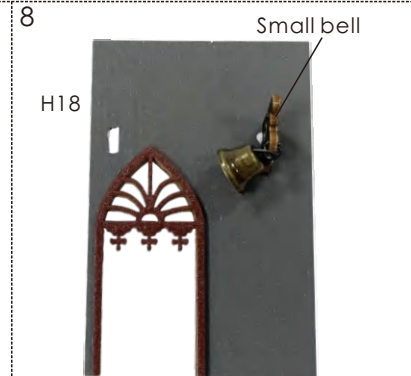
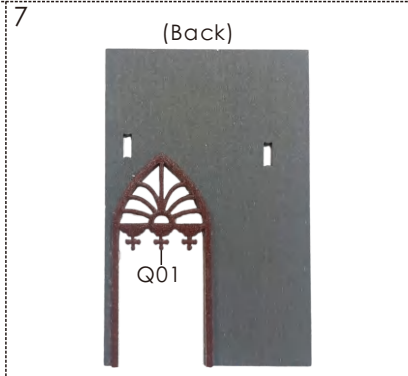
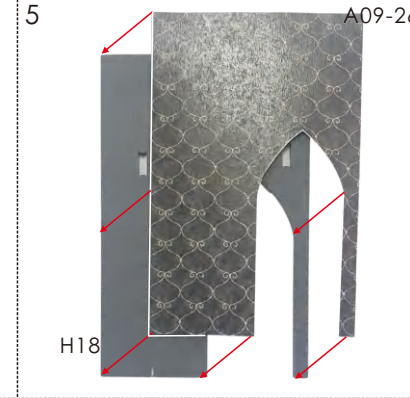
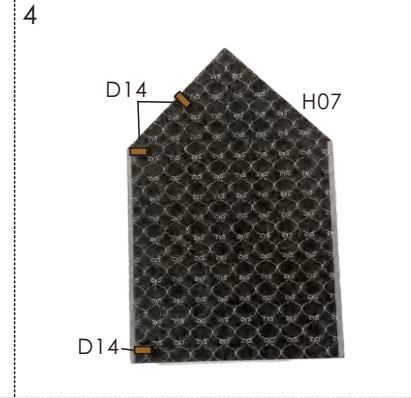
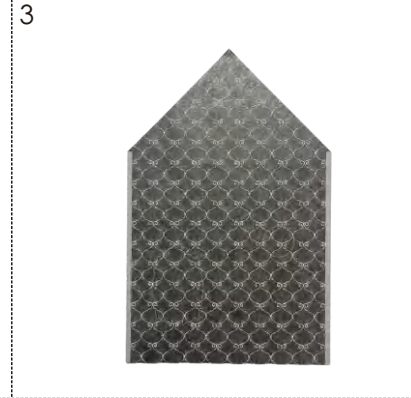
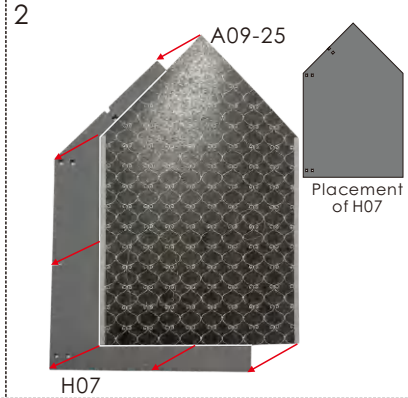

Cut out V03 according to the template paper and stick it on

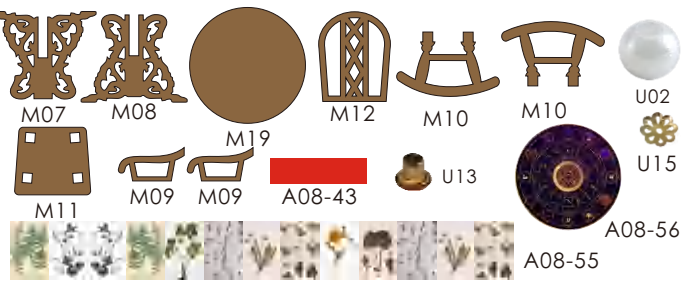
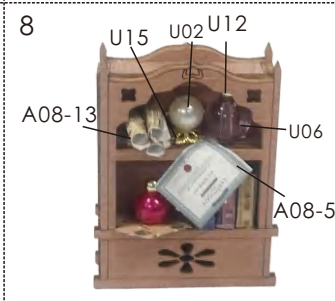
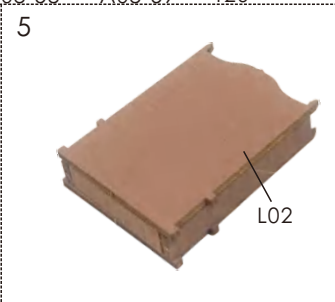
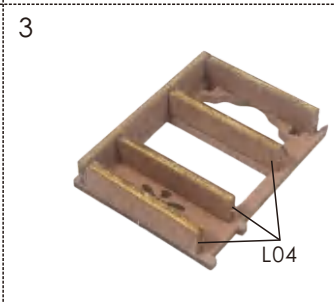
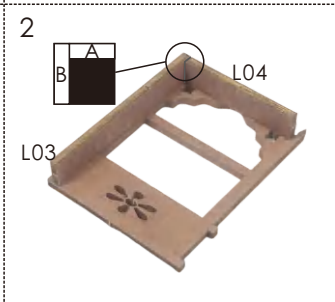
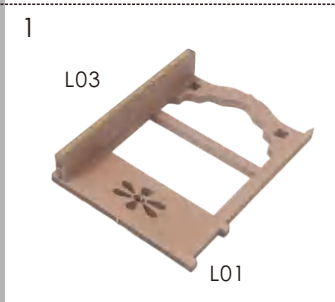
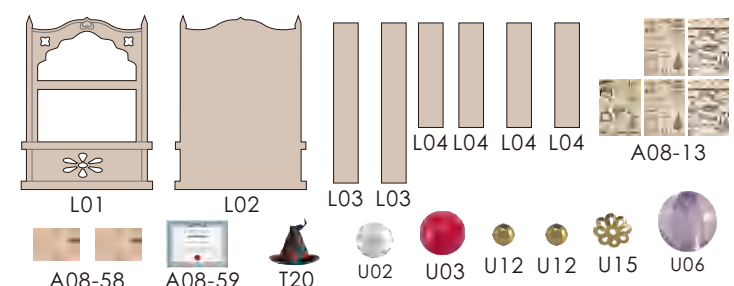
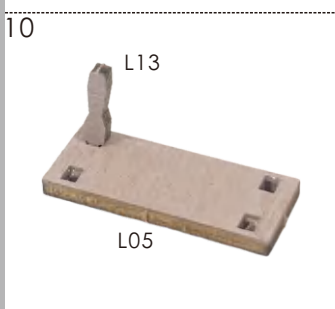
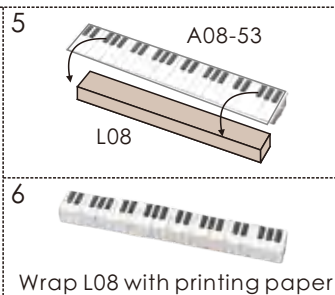
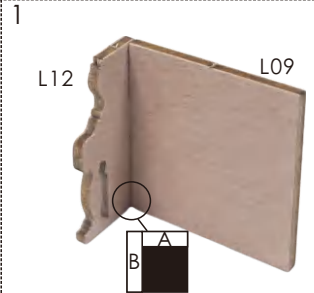
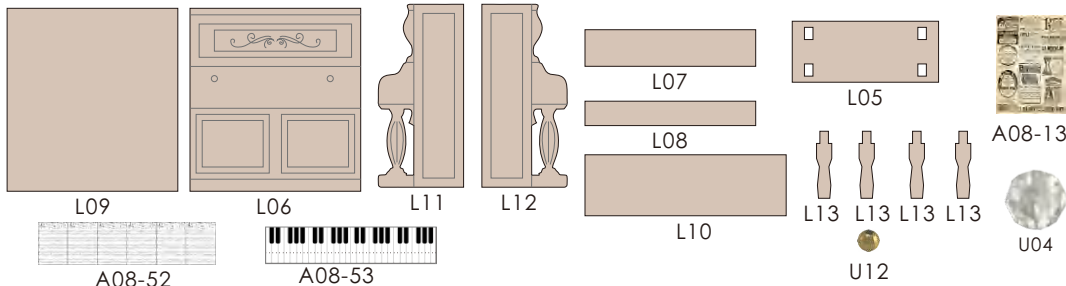

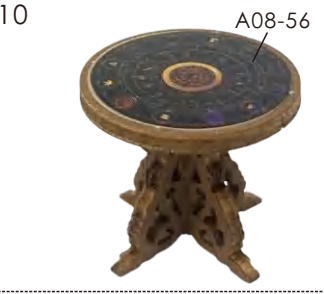
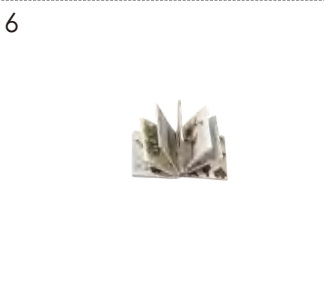
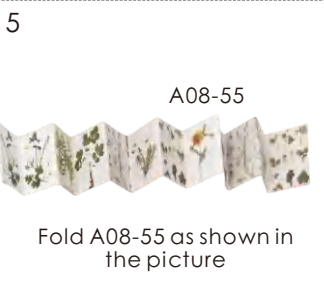
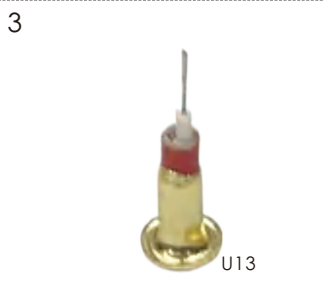
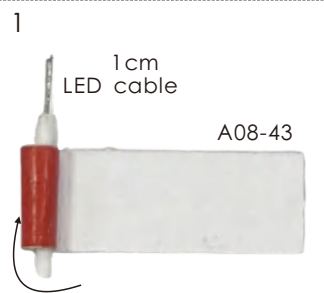

Easel

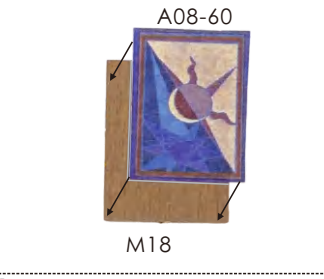
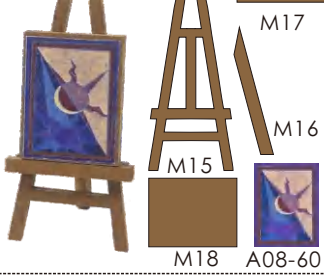

Landing sign

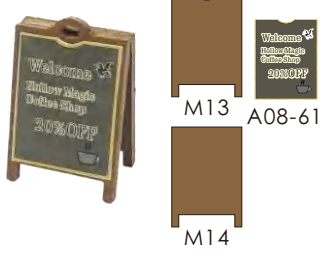

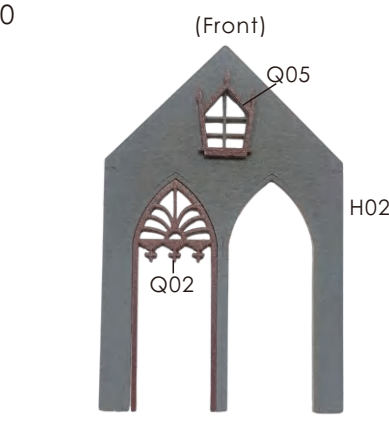
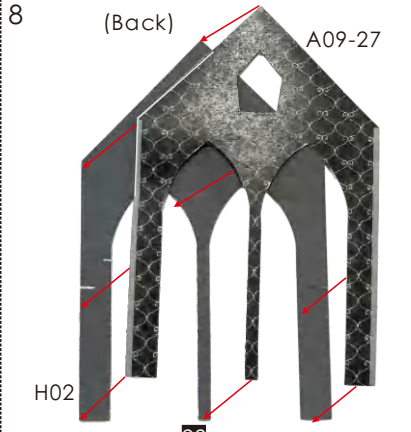
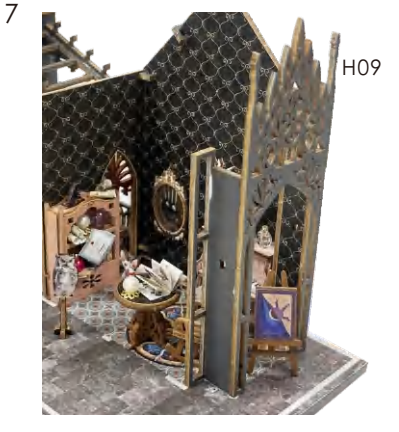
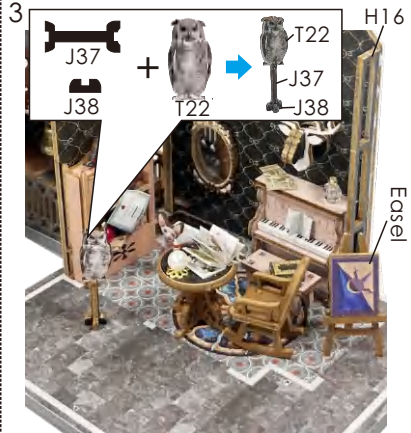
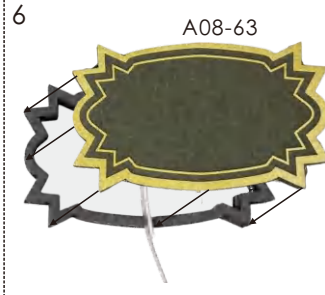
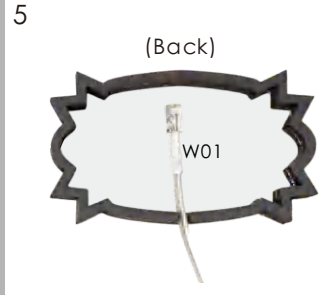
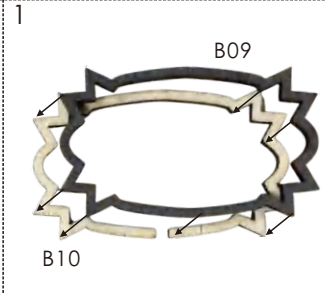

Stick the printing paper onto H02 (note to stick it on the side without lines)

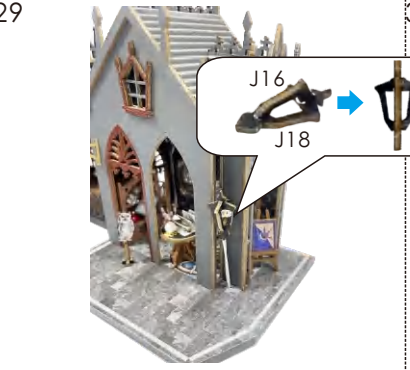
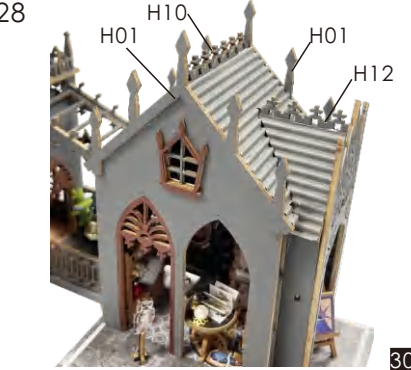
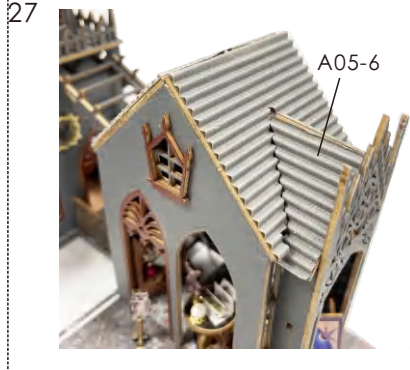
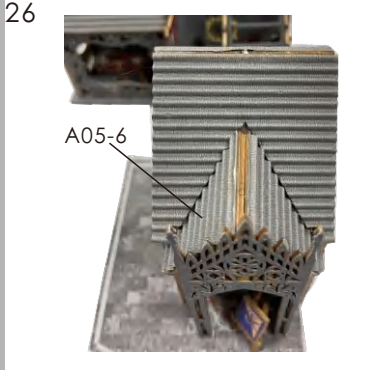
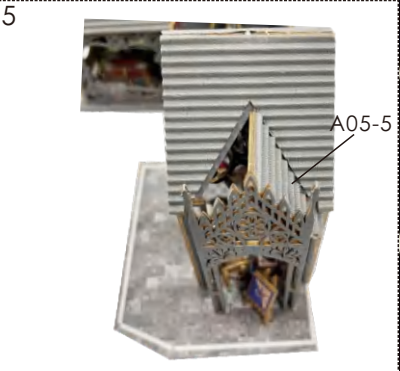
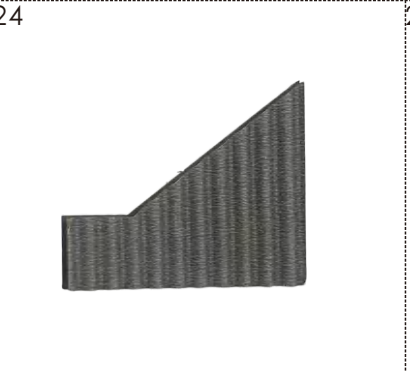
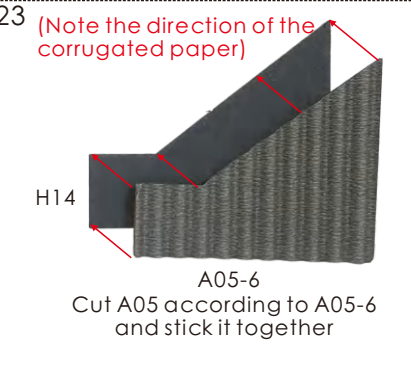
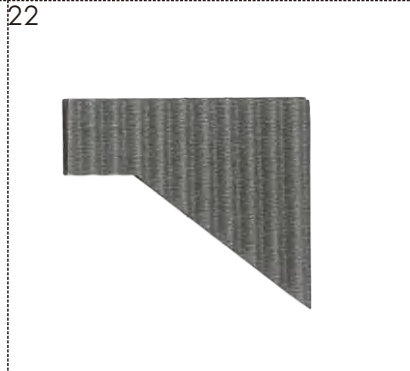
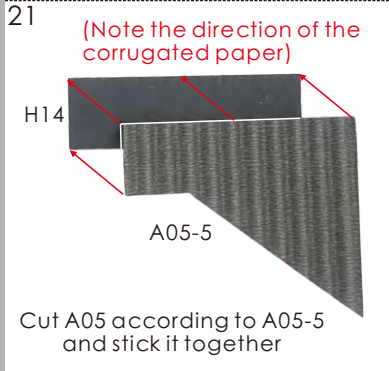
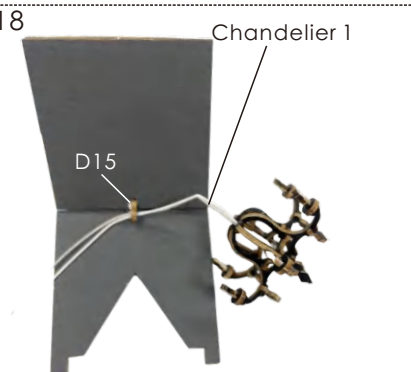
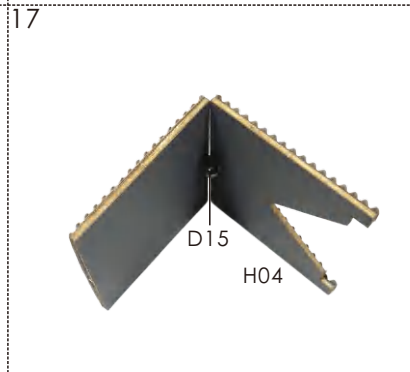
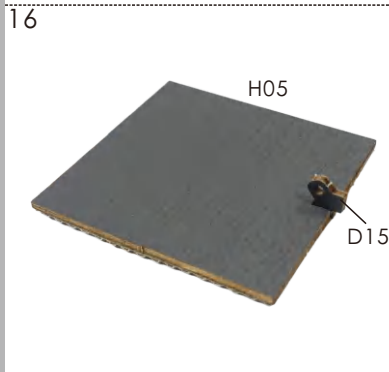
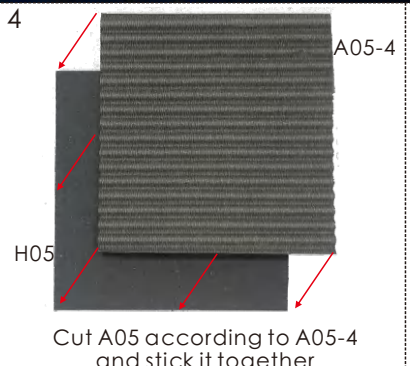
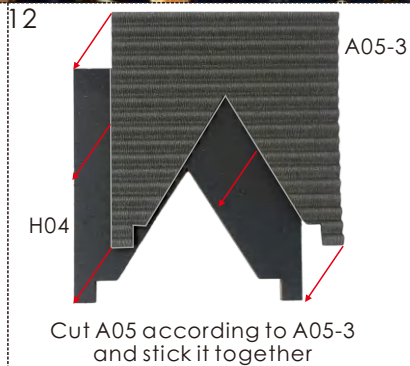



Cut A05 according to A05-7 and stick it together

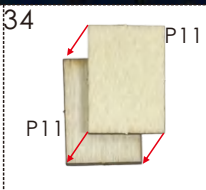

35 (need 3 pieces)

P11

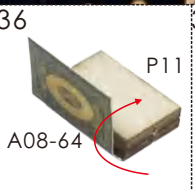

37

Stick the printing paper together



39

Make the other 2 books in the same way

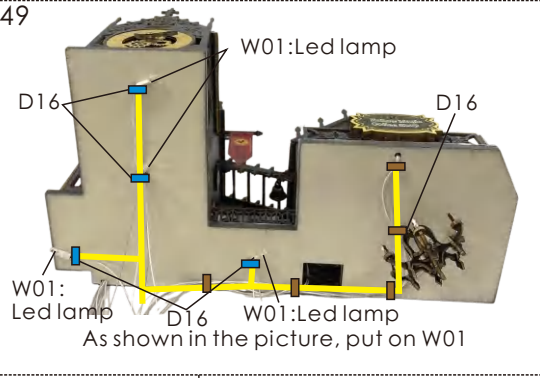
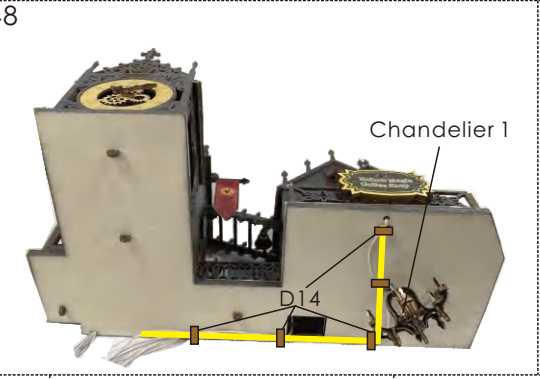
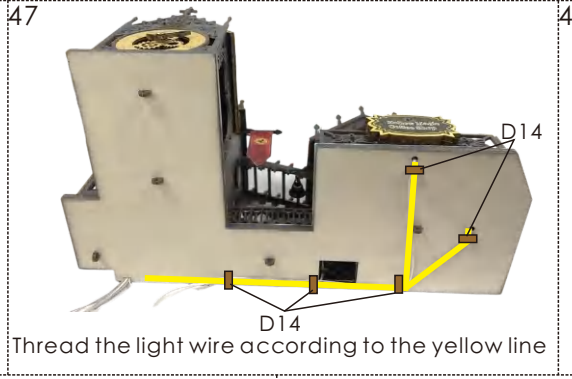
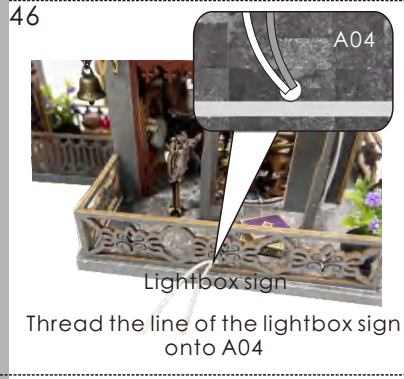
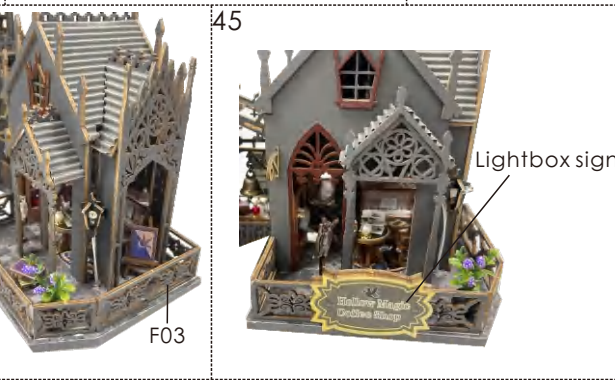
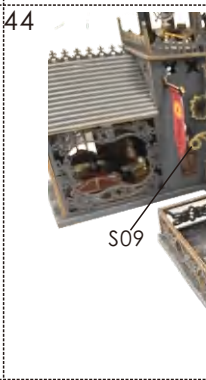
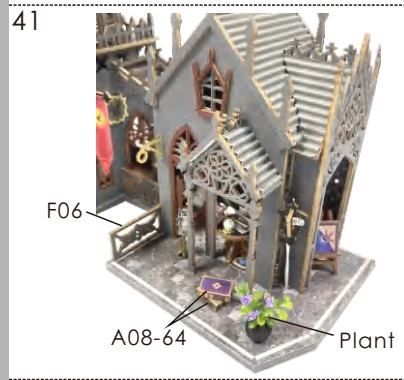

Bookshelf

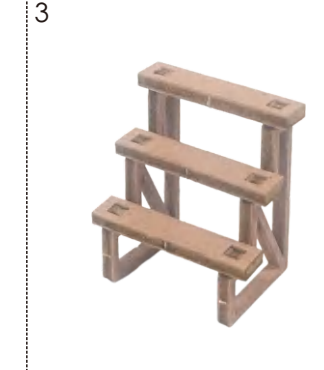
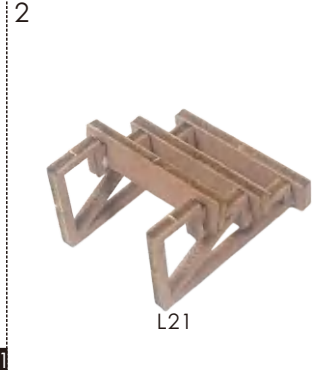
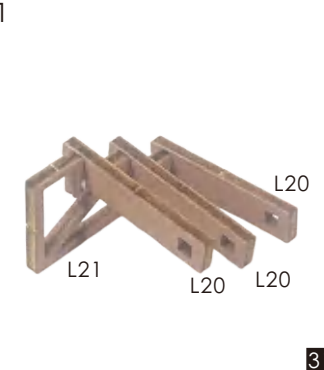
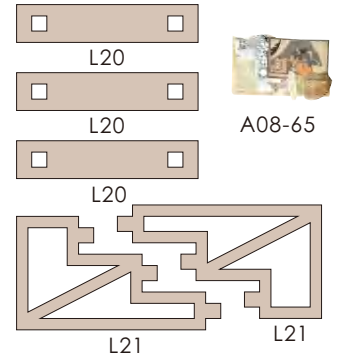

Broom

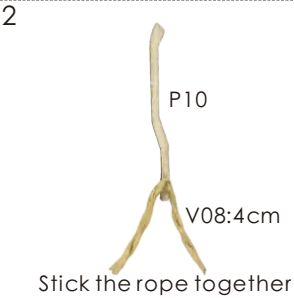

Bench

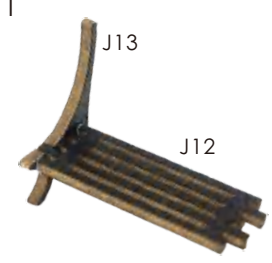
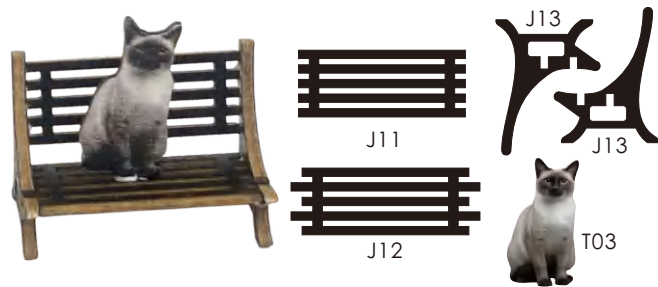

Astrologer

Before making, cut out A06 according to the template

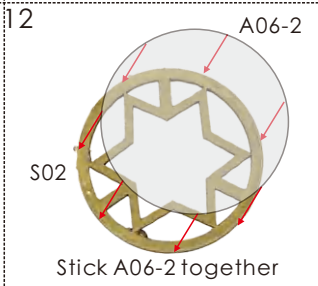
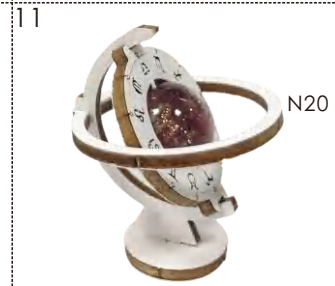
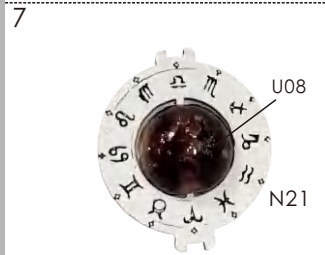
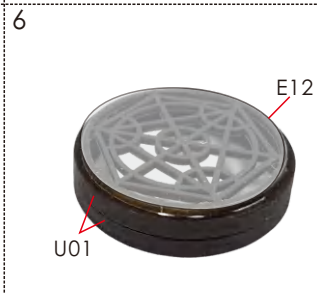
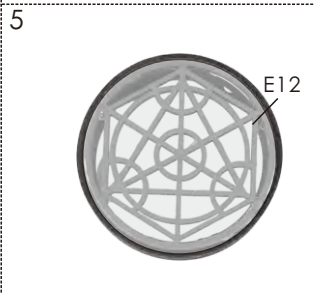
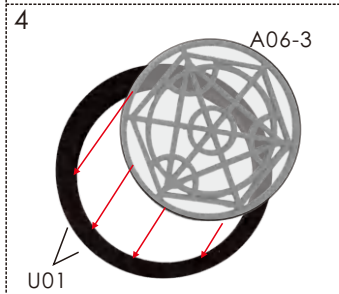
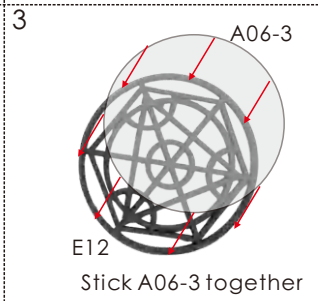
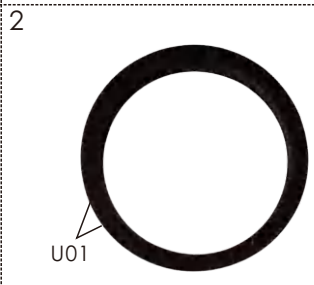
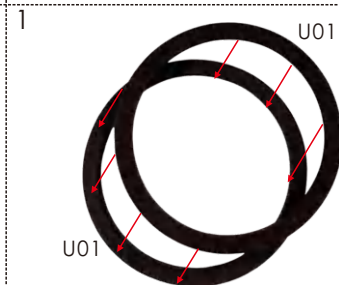
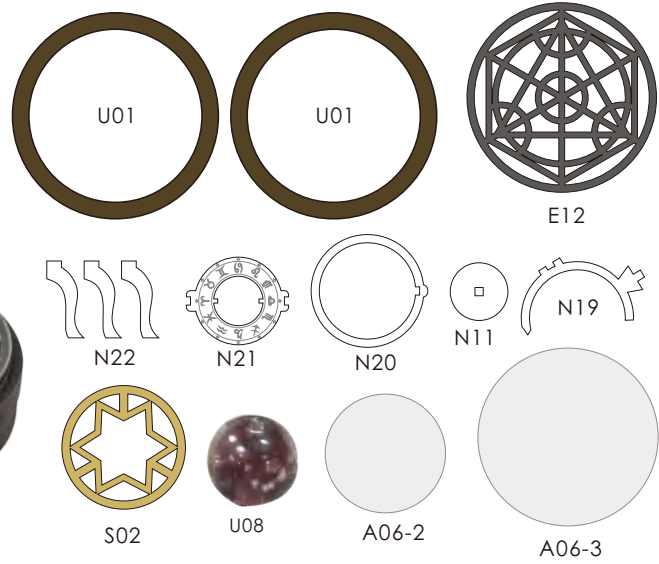

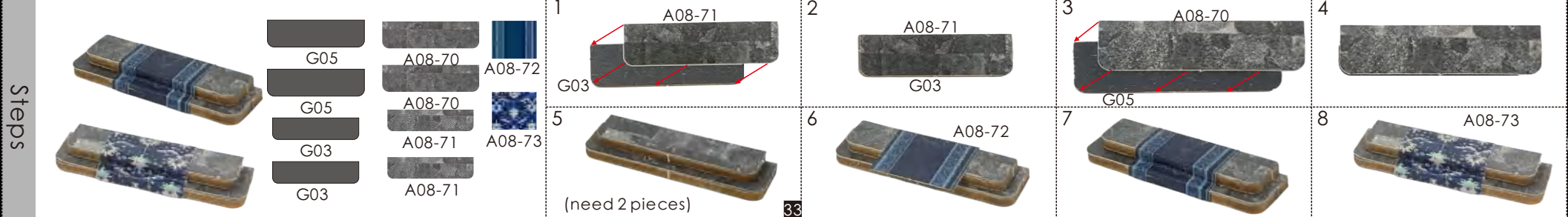
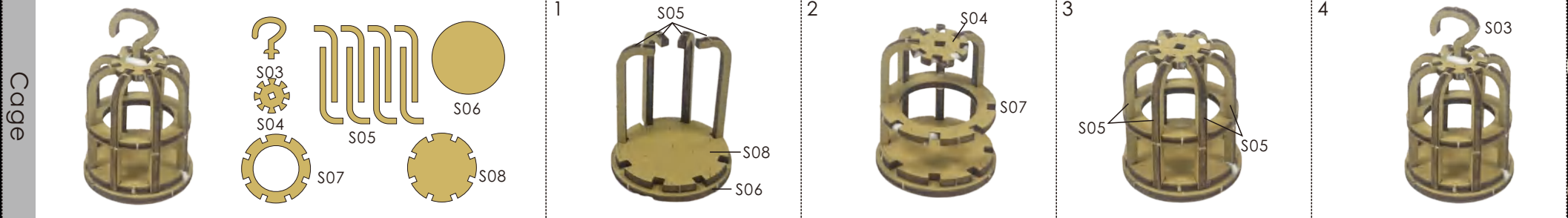
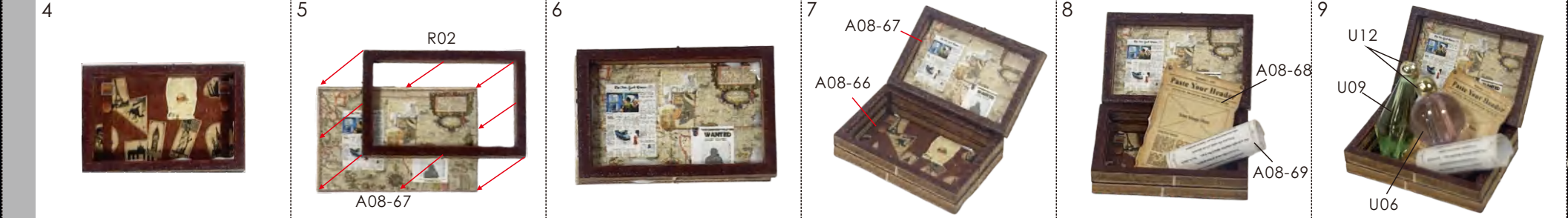
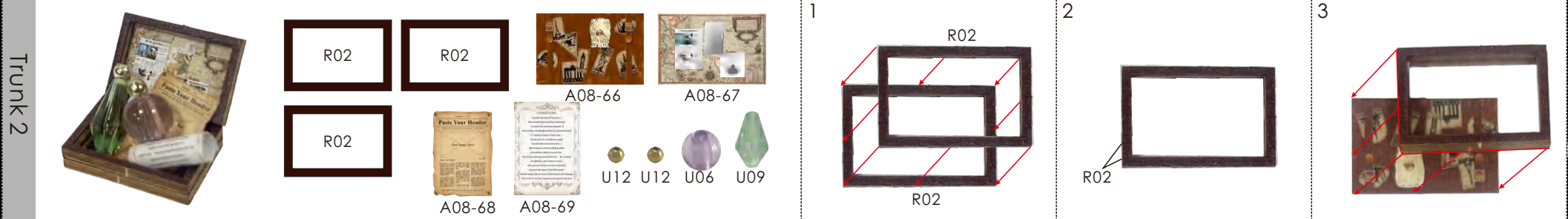

Mailbox

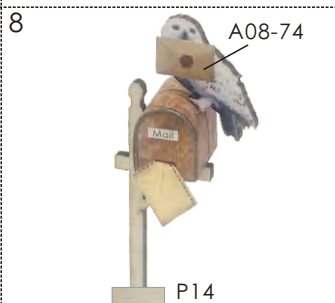
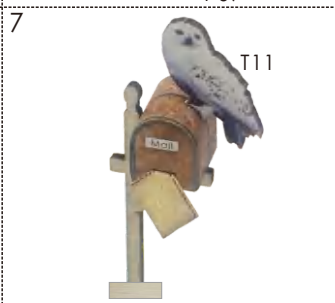
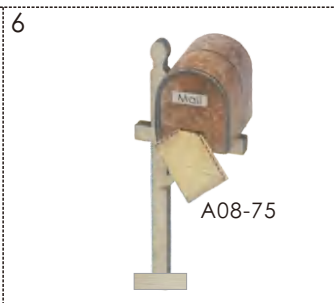
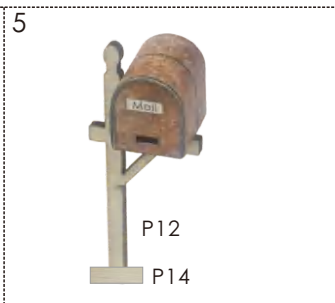
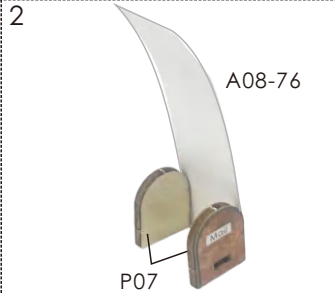
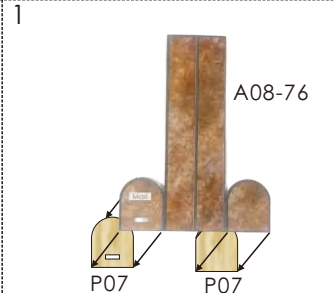
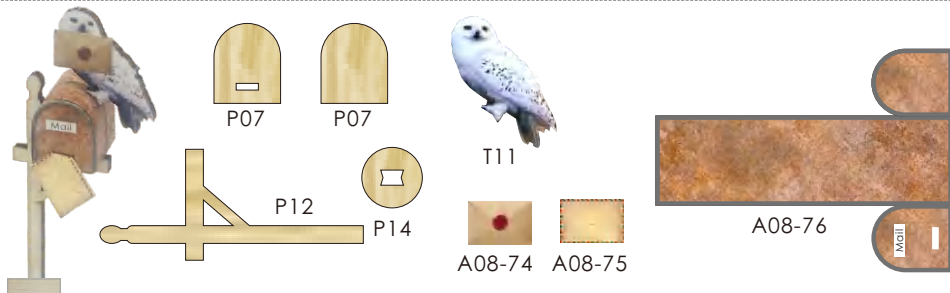

Magic ball 2

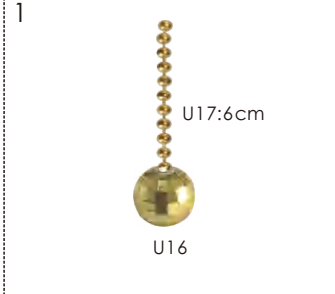

Outer frame

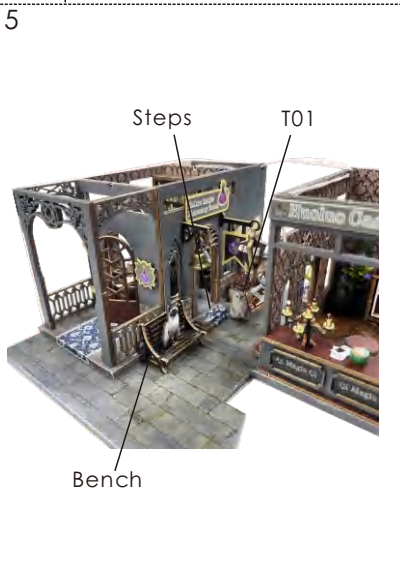
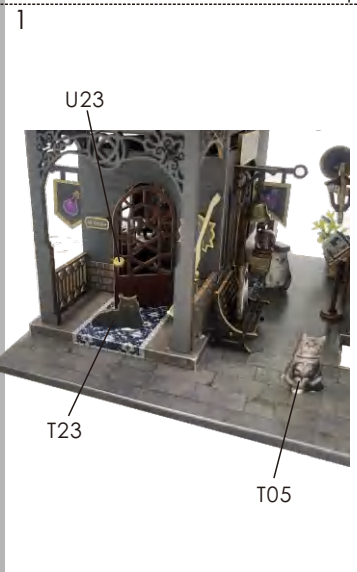

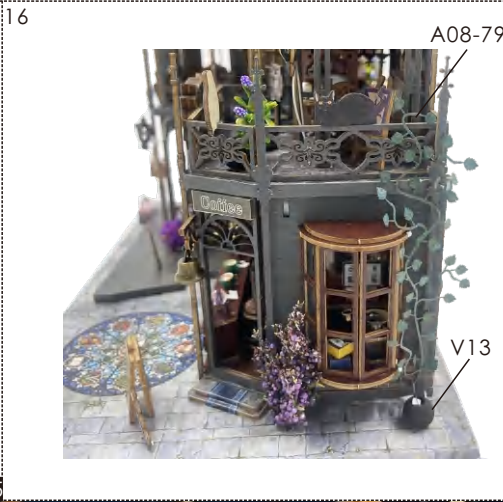
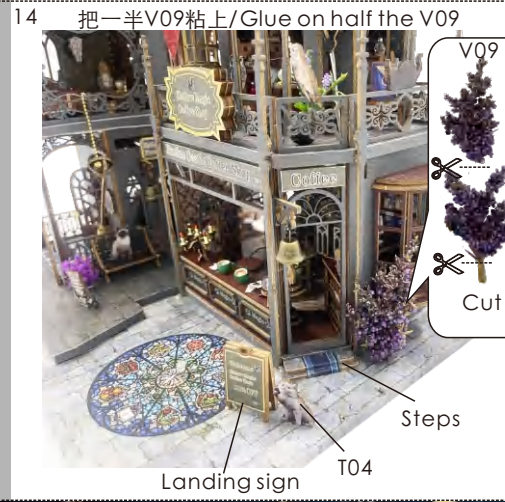
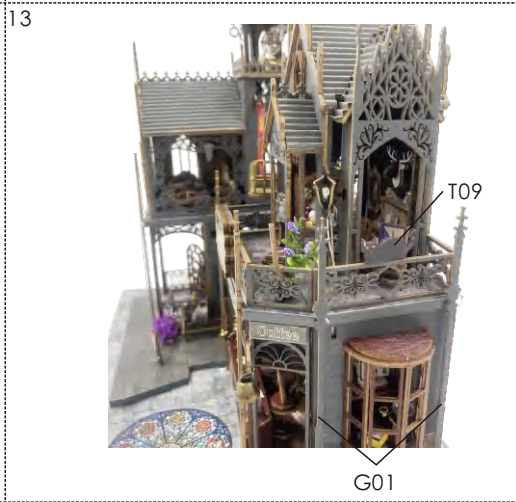
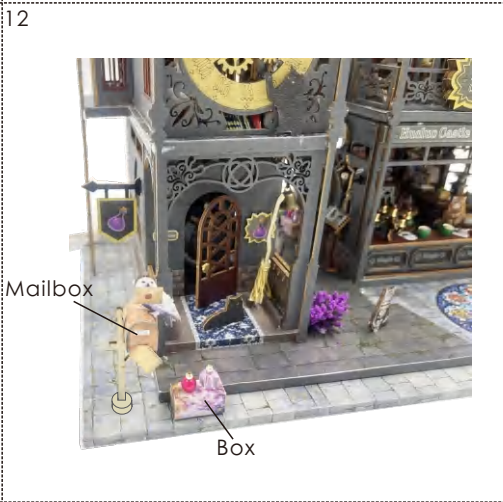
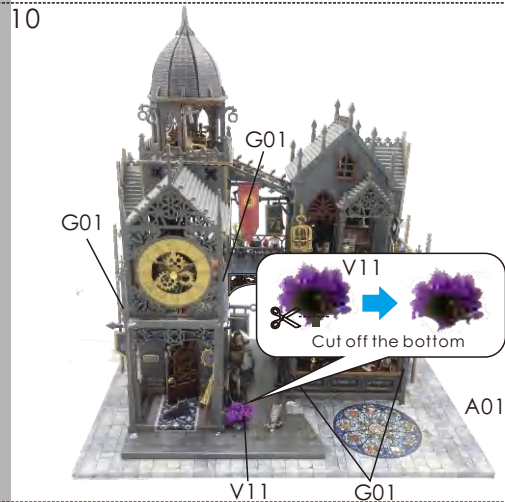
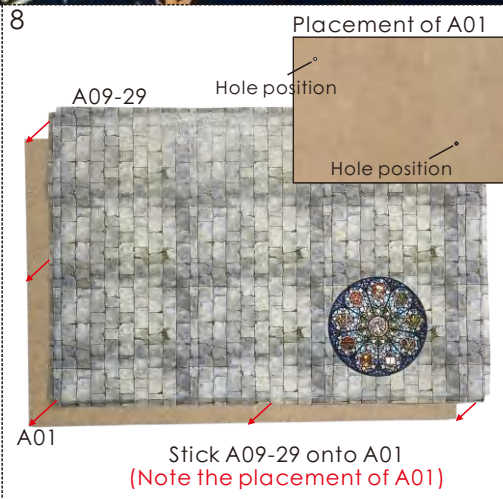
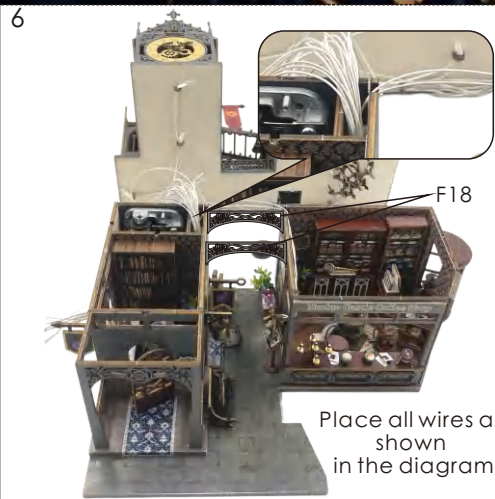

18

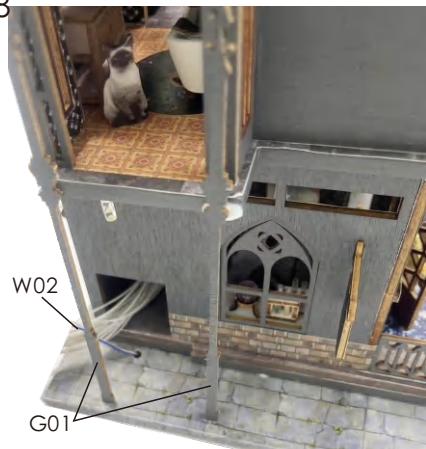

Take the wire out of the other hole of A02

19



F18

20



V13

A08-82

Half of V09

21

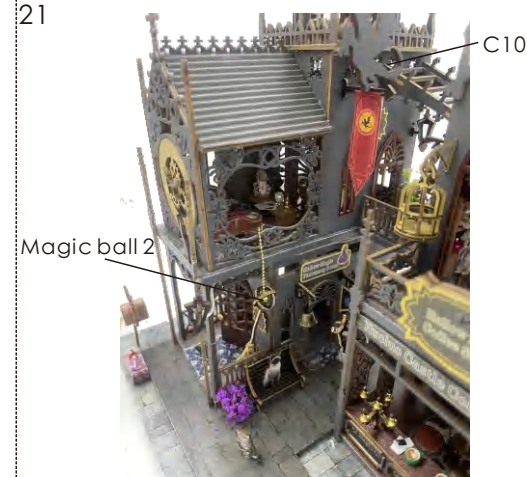

C10

Magic ball 2

22



T12

Trunk 2

23



J06

Magic ball 1

Astrologer

A08-80

24

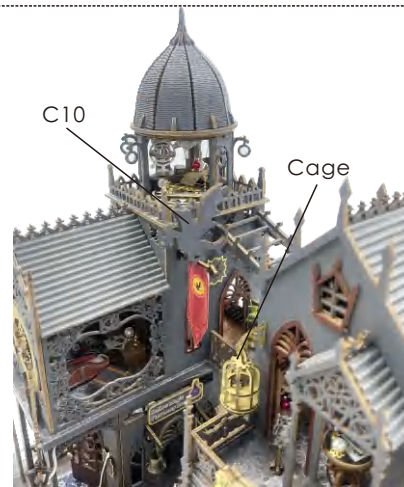

C10

Cage

25

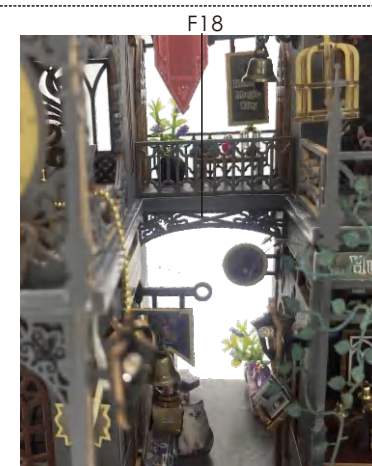

F18

Vending machine

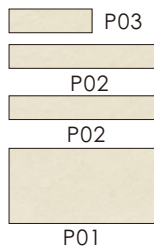

A08-81

1

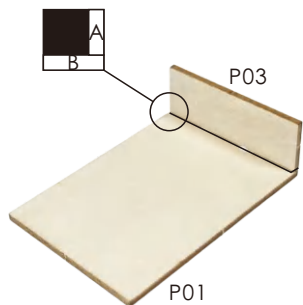

P03

P01

2

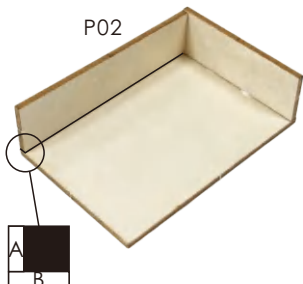

P02

P01

3

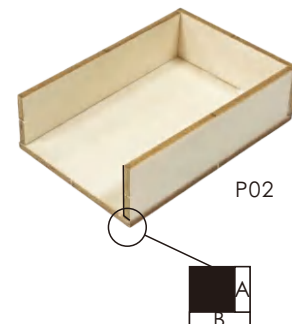

P02

A
B

4



A08-81

5



Disclaimer: This wire cannot be plugged into the output socket

- LED lights before use, should can test the light
- Can use two AAA batteries
- The positive and negative poles of the battery are aligned and the battery is installed
- Non-rechargeable batteries, cannot be charged
- Rechargeable batteries can only be charged under adult supervision
- Rechargeable batteries should be removed from the toy before charging
- Different types of batteries or old and new batteries cannot be mixed
- Batteries should be inserted with correct polarity
- Exhausted batteries should be removed from the toy
- The power terminal must not be short-circuited

1

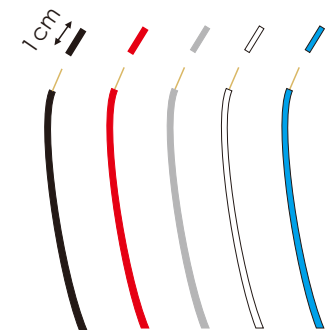

Peel off 1 cm of rubber from the heads of all wires

2

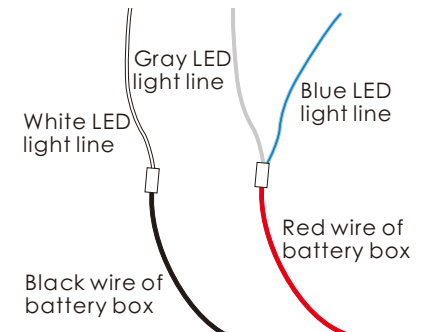

Connect the Black and LED white wires of the battery box, as well as the red and gray LED gray wires of the battery box, respectively

3

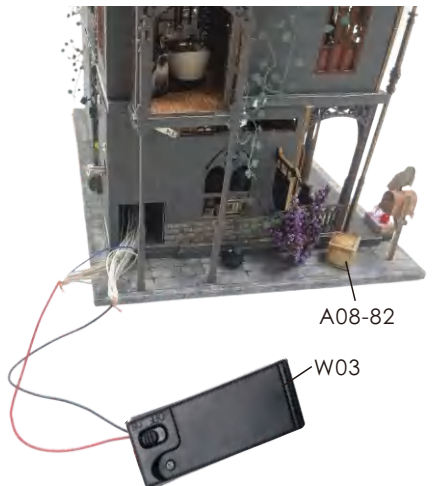

4

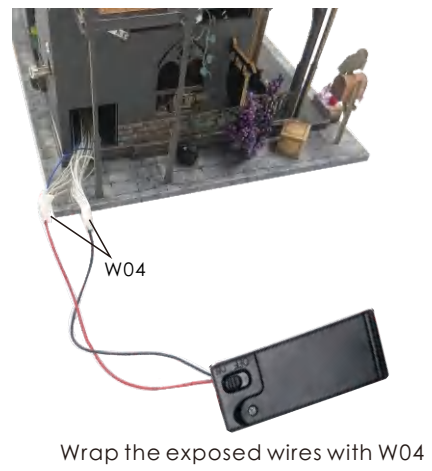

5

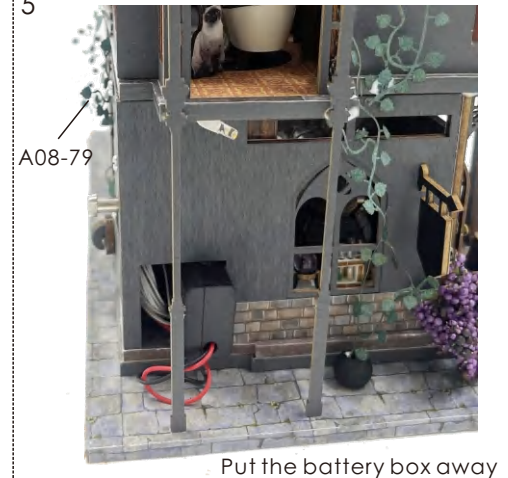

5







The instruction manual should be keep, after assembled.